

User Manual

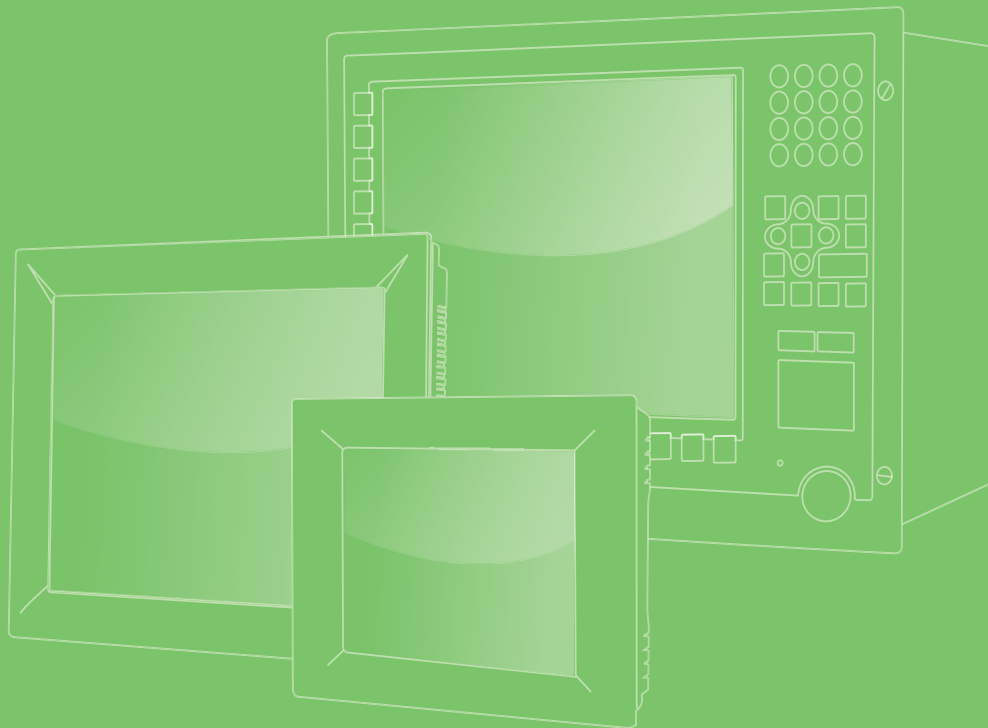

TPC-100WX Series

Touch Panel Computer
7"/10.1" High Brightness ARM
based HMI for Outdoor
Application

ADVANTECH

Enabling an Intelligent Planet

限用物質含有情況標示聲明書
Declaration of the Presence Condition of the Restricted Substances Marking

設備名稱 電腦 Equipment name	型號 (型式): Designation (Type)					
	TPC-107WX-N32AA TPC-107WX-N32YA TPC-110WX-N32AA TPC-110WX-N32YA					
單元 Unit	限用物質及其化學符號 Restricted substances and their chemical symbols					
	鉛 Lead (Pb)	汞 Mercury (Hg)	鎘 Cadmium (Cd)	六價鉻 Hexavalent chromium (Cr ⁺⁶)	多溴聯苯 Polybrominated biphenyls (PBB)	多溴二苯醚 Polybrominated diphenyl ethers (PBDE)
電路板	—	○	○	○	○	○
內外殼 (外殼、內 部框架 ... 等)	○	○	○	○	○	○
其它固定 組件 (螺 絲、夾具、 卡榫)	—	○	○	○	○	○
觸控模組	—	○	○	○	○	○
液晶面板	—	○	○	○	○	○
線材	○	○	○	○	○	○
備考 1. “超出 0.1 wt %” 及 “超出 0.01 wt %” 係指限用物質之百分比含量超出百分比含量基準值。 Note 1. “Exceeding 0.1 wt %” and “exceeding 0.01 wt %” indicate that the content of the restricted substance exceeds the defined concentration limit.						
備考 2. “○” 係指該項限用物質之百分比含量未超出百分比含量基準值。 Note 2. “○” indicates that the content of the restricted substance does not exceed the defined concentration limit.						
備考 3. “—” 係指該項限用物質為排除項目。 Note 3. “-” indicates that the restricted substance is not present in the product.						

製造商：研華股份有限公司
地址：台北市內湖區瑞光路 26 巷 20 弄 1 號
電話：02-27927818

Manufacturer: ADVANTECH Co., Ltd.
Address: No. 1 Alley 20 Lane 26, Rueiguang Rd., Neihu District, Taipei City
Telephone: 02-27927818

Copyright

The documentation and the software included with this product are copyrighted 2025 by Advantech Co., Ltd. All rights are reserved. Advantech Co., Ltd. reserves the right to make improvements in the products described in this manual at any time without notice. No part of this manual may be reproduced, copied, translated, or transmitted in any form or by any means without the prior written permission of Advantech Co., Ltd. The information provided in this manual is intended to be accurate and reliable. However, Advantech Co., Ltd. assumes no responsibility for its use, nor for any infringements of the rights of third parties that may result from its use.

Acknowledgments

NXP and Freescale are registered trademarks of NXP Semiconductors N.V.
All other product names or trademarks are properties of their respective owners.

This manual is applicable to the following models:

TPC-107WX/TPC-110WX

TPC-107WX-N32YA

TPC107WXN32YA2401-T,	TPC107WXN32YA2402-T,	TPC107WXN32YA2403-T,
TPC107WXN32YA2404-T,	TPC107WXN32YA2405-T,	TPC107WXN32YA2406-T,
TPC107WXN32YA2501-T,	TPC107WXN32YA2502-T,	TPC107WXN32YA2503-T,
TPC107WXN32YA2504-T,	TPC107WXN32YA2505-T,	TPC107WXN32YA2506-T,
TPC107WXN32YA2601-T,	TPC107WXN32YA2602-T,	TPC107WXN32YA2603-T,
TPC107WXN32YA2604-T,	TPC107WXN32YA2605-T,	TPC107WXN32YA2606-T,
TPC107WXN32YA2701-T,	TPC107WXN32YA2702-T,	TPC107WXN32YA2703-T,
TPC107WXN32YA2704-T,	TPC107WXN32YA2705-T,	TPC107WXN32YA2706-T,
TPC107WXN32YA2801-T,	TPC107WXN32YA2802-T,	TPC107WXN32YA2803-T,
TPC107WXN32YA2804-T,	TPC107WXN32YA2805-T,	TPC107WXN32YA2806-T,
TPC107WXN32YA2901-T,	TPC107WXN32YA2902-T,	TPC107WXN32YA2903-T,
TPC107WXN32YA2904-T,	TPC107WXN32YA2905-T,	TPC107WXN32YA2906-T

TPC-107WX-N32AA

TPC107WXN32AA2401-T,	TPC107WXN32AA2402-T,	TPC107WXN32AA2403-T,
TPC107WXN32AA2404-T,	TPC107WXN32AA2405-T,	TPC107WXN32AA2406-T,
TPC107WXN32AA2501-T,	TPC107WXN32AA2502-T,	TPC107WXN32AA2503-T,
TPC107WXN32AA2504-T,	TPC107WXN32AA2505-T,	TPC107WXN32AA2506-T,
TPC107WXN32AA2601-T,	TPC107WXN32AA2602-T,	TPC107WXN32AA2603-T,
TPC107WXN32AA2604-T,	TPC107WXN32AA2605-T,	TPC107WXN32AA2606-T,
TPC107WXN32AA2701-T,	TPC107WXN32AA2702-T,	TPC107WXN32AA2703-T,
TPC107WXN32AA2704-T,	TPC107WXN32AA2705-T,	TPC107WXN32AA2706-T,
TPC107WXN32AA2801-T,	TPC107WXN32AA2802-T,	TPC107WXN32AA2803-T,
TPC107WXN32AA2804-T,	TPC107WXN32AA2805-T,	TPC107WXN32AA2806-T,
TPC107WXN32AA2901-T,	TPC107WXN32AA2902-T,	TPC107WXN32AA2903-T,
TPC107WXN32AA2904-T,	TPC107WXN32AA2905-T,	TPC107WXN32AA2906-T,

Part No. 2001100W00

Printed in China

Edition 1

November 2024

TPC-110WX-N32YA

TPC110WXN32YA2401-T,	TPC110WXN32YA2402-T,	TPC110WXN32YA2403-T,
TPC110WXN32YA2404-T,	TPC110WXN32YA2405-T,	TPC110WXN32YA2406-T,
TPC110WXN32YA2501-T,	TPC110WXN32YA2502-T,	TPC110WXN32YA2503-T,
TPC110WXN32YA2504-T,	TPC110WXN32YA2505-T,	TPC110WXN32YA2506-T,
TPC110WXN32YA2601-T,	TPC110WXN32YA2602-T,	TPC110WXN32YA2603-T,
TPC110WXN32YA2604-T,	TPC110WXN32YA2605-T,	TPC110WXN32YA2606-T,
TPC110WXN32YA2701-T,	TPC110WXN32YA2702-T,	TPC110WXN32YA2703-T,
TPC110WXN32YA2704-T,	TPC110WXN32YA2705-T,	TPC110WXN32YA2706-T,
TPC110WXN32YA2801-T,	TPC110WXN32YA2802-T,	TPC110WXN32YA2803-T,
TPC110WXN32YA2804-T,	TPC110WXN32YA2805-T,	TPC110WXN32YA2806-T,
TPC110WXN32YA2901-T,	TPC110WXN32YA2902-T,	TPC110WXN32YA2903-T,
TPC110WXN32YA2904-T,	TPC110WXN32YA2905-T,	TPC110WXN32YA2906-T

TPC-110WX-N32AA

TPC110WXN32AA2401-T,	TPC110WXN32AA2402-T,	TPC110WXN32AA2403-T,
TPC110WXN32AA2404-T,	TPC110WXN32AA2405-T,	TPC110WXN32AA2406-T,
TPC110WXN32AA2501-T,	TPC110WXN32AA2502-T,	TPC110WXN32AA2503-T,
TPC110WXN32AA2504-T,	TPC110WXN32AA2505-T,	TPC110WXN32AA2506-T,
TPC110WXN32AA2601-T,	TPC110WXN32AA2602-T,	TPC110WXN32AA2603-T,
TPC110WXN32AA2604-T,	TPC110WXN32AA2605-T,	TPC110WXN32AA2606-T,
TPC110WXN32YA2701-T,	TPC110WXN32AA2702-T,	TPC110WXN32AA2703-T,
TPC110WXN32AA2704-T,	TPC110WXN32AA2705-T,	TPC110WXN32AA2706-T,
TPC110WXN32AA2801-T,	TPC110WXN32AA2802-T,	TPC110WXN32AA2803-T,
TPC110WXN32AA2804-T,	TPC110WXN32AA2805-T,	TPC110WXN32AA2806-T,
TPC110WXN32AA2901-T,	TPC110WXN32AA2902-T,	TPC110WXN32AA2903-T,
TPC110WXN32AA2904-T,	TPC110WXN32AA2905-T,	TPC110WXN32AA2906-T

TPC-107WX-N32YAU

TPC-107WX-N32AAU

TPC-110WX-N32YAU

TPC-110WX-N32AAU

Product Warranty (2 years)

Advantech warrants the original purchaser that each of its products will be free from defects in materials and workmanship for two years from the date of purchase.

This warranty does not apply to any products that have been repaired or altered by persons other than repair personnel authorized by Advantech, or products that have been subject to misuse, abuse, accident, or improper installation. Advantech assumes no liability under the terms of this warranty as a consequence of such events.

Because of Advantech's high quality-control standards and rigorous testing, most customers never need to use our repair service. If an Advantech product is defective, it will be repaired or replaced free of charge during the warranty period. For out-of-warranty repairs, customers will be billed according to the cost of replacement materials, service time, and freight. Please consult your dealer for more details.

If you believe your product to be defective, follow the steps outlined below.

1. Collect all the information about the problem encountered. (For example, CPU speed, Advantech products used, other hardware and software used, etc.) Note anything abnormal and list any onscreen messages displayed when the problem occurs.
2. Call your dealer and describe the problem. Please have your manual, product, and any helpful information readily available.
3. If your product is diagnosed as defective, obtain a return merchandise authorization (RMA) number from your dealer. This allows us to process your return more quickly.
4. Carefully pack the defective product, a completed Repair and Replacement Order Card, and a proof of purchase date (such as a photocopy of your sales receipt) into a shippable container. Products returned without a proof of purchase date are not eligible for warranty service.
5. Write the RMA number clearly on the outside of the package and ship the package prepaid to your dealer.

Technical Support and Assistance

1. Visit the Advantech website at www.advantech.com/support to obtain the latest product information.
2. Contact your distributor, sales representative, or Advantech's customer service center for technical support if you need additional assistance. Please have the following information ready before calling:
 - Product name and serial number
 - Description of your peripheral attachments
 - Description of your software (operating system, version, application software, etc.)
 - A complete description of the problem
 - The exact wording of any error messages

Declaration of Conformity

CE

This product has passed the CE test for environmental specifications when shielded cables are used for external wiring. We recommend the use of shielded cables. This type of cable is available from Advantech. Please contact your local supplier for ordering information.

Test conditions for passing also include the equipment being operated within an industrial enclosure. In order to protect the product from damage caused by electrostatic discharge (ESD) and EMI leakage, we strongly recommend the use of CE-compliant industrial enclosure products.

FCC Class A

This equipment has been tested and found to comply with the limits for a Class A digital device, pursuant to part 15 of the FCC Rules. These limits are designed to provide reasonable protection against harmful interference when the equipment is operated in a commercial environment. This equipment generates, uses, and can radiate radio frequency energy and, if not installed and used in accordance with the instruction manual, may cause harmful interference to radio communications. Operation of this equipment in a residential area is likely to cause harmful interference. In this event, users are required to correct the interference at their own expense.

甲類資訊技術設備

警告使用者：為避免電磁干擾，本產品不應安裝或使用於住宅環境。

Warnings, Cautions, and Notes

Warning! Warnings indicate conditions that if not observed can cause personal injury!



Les avertissements indiquent des conditions qui, si elles ne sont pas respectées, peuvent blesser!

Warning! Do not expose the equipment to direct sunlight, or install the equipment in an environment with direct sunlight, as this may cause damage.



N'exposez pas l'équipement à la lumière directe du soleil et n'installez pas l'équipement dans un environnement exposé à la lumière directe du soleil, car cela pourrait causer des dommages.

Caution! Cautions are included to help prevent hardware damage and data losses. For example,



Batteries are at risk of exploding if incorrectly installed. Do not attempt to recharge, force open, or heat the battery. Replace the battery only with the same or equivalent type as recommended by the manufacturer. Discard used batteries according to the manufacturer's instructions.

Des précautions sont incluses pour aider à prévenir les dommages matériels et les données pertes. Par exemple,

Les piles risquent d'exploser si elles sont mal installées. Ne pas tenter pour recharger, forcer l'ouverture ou chauffer la batterie. Remplacer la batterie uniquement avec le même type ou un type équivalent recommandé par le fabricant. Jetez les piles usagées conformément aux instructions du fabricant.

Note! Notes provide additional optional information.



Les remarques fournissent des informations facultatives supplémentaires.

Safety Instructions

1. Read these safety instructions carefully.
2. Retain this user manual for future reference.
3. Disconnect the equipment from all power outlets before cleaning. Use only a damp cloth for cleaning. Do not use liquid or spray detergents.
4. For pluggable equipment, the power outlet socket must be located near the equipment and easily accessible.
5. Protect the equipment from humidity.
6. Place the equipment on a reliable surface during installation. Dropping or letting the equipment fall may cause damage.
7. The openings on the enclosure are for air convection. Protect the equipment from overheating. Do not cover the openings.
8. Ensure that the voltage of the power source is correct before connecting the equipment to a power outlet.
9. Position the power cord away from high-traffic areas. Do not place anything over the power cord.
10. All cautions and warnings on the equipment should be noted.
11. If the equipment is not used for a long time, disconnect it from the power source to avoid damage from transient overvoltage.
12. Never pour liquid into an opening. This may cause fire or electrical shock.
13. Never open the equipment. For safety reasons, the equipment should be opened only by qualified service personnel.
14. If any of the following occurs, have the equipment checked by service personnel:
 - The power cord or plug is damaged.
 - Liquid has penetrated the equipment.
 - The equipment has been exposed to moisture.
 - The equipment is malfunctioning, or does not operate according to the user manual.
 - The equipment has been dropped and damaged.
 - The equipment shows obvious signs of breakage.
15. Do not leave the equipment in an environment with a storage temperature of below -30°C (-22°F) or above 70°C (158°F) as this may damage the components. The equipment should be kept in a controlled environment.
16. CAUTION: Batteries are at risk of exploding if incorrectly replaced. Replace only with the same or equivalent type as recommended by the manufacturer. Discard used batteries according to the manufacturer's instructions.
17. In accordance with IEC 704-1:1982 specifications, the sound pressure level at the operator's position does not exceed 70 dB (A).
18. This product is not intended for use by children (this product is not a toy).
19. This equipment is not suitable for use in locations where children are likely to be present.
20. By means of a power cord connected to a socket-outlet with earthing connection.

Assurez-vous que la tension de la source d'alimentation est correcte avant de connecter l'équipement à la prise de courant. Au moyen d'un cordon d'alimentation connecté à une prise de courant avec mise à la terre.
21. Caution: The wire of the protective bonding conductor shall be green-and-yellow, 22AWG/0.3mm² minimum.

Attention: Le fil du conducteur de liaison de protection doit être vert et jaune, 22AWG/0,3 mm² minimum.

DISCLAIMER: These instructions are provided according to IEC 704-1 standards. Advantech disclaims all responsibility for the accuracy of any statements contained herein.

Caution! *Danger d'explosion si la batterie est mal remplacée. Remplacer uniquement par le même type ou équivalent recommandé par le fabricant.*
Jeter les piles usagées selon les instructions du fabricant.



安全指示

1. 請仔細閱讀此安全操作說明。
2. 請妥善保存此用戶手冊供日後參考。
3. 用濕抹布清洗設備前，請從插座拔下電源線。請不要使用液體或去汙噴霧劑清洗設備。
4. 對於使用電源線的設備，設備周圍必須有容易接觸到的電源插座。
5. 請不要在潮濕環境中使用設備。
6. 請在安裝前確保設備放置在可靠的平面上，意外跌落可能會導致設備損壞。
7. 設備外殼的開口是用於空氣對流，從而防止設備過熱。**請不要覆蓋這些開口。**
8. 當您連接設備到電源插座上前，請確認電源插座的電壓是否符合要求。
9. 請將電源線佈置在人們不易絆到的位置，並不要在電源線上覆蓋任何雜物。
10. 請注意設備上的所有警告和注意標示。
11. 如果長時間不使用設備，請將其同電源插座斷開，避免設備被超標的電壓波動損壞。
12. 請不要讓任何液體流入通風口，以免引起火災或者短路。
13. 請不要自行打開設備。為了確保您的安全，請由經過認證的工程師來打開設備。
14. 如遇下列情況，請由專業人員來維修：
 - 電源線或者插頭損壞；
 - 設備內部有液體流入；
 - 設備曾暴露在過於潮濕的環境中使用；
 - 設備無法正常工作，或您無法通過用戶手冊來使其正常工作；
 - 設備跌落或者損壞；
 - 設備有明顯的外觀破損。
15. 請不要把設備保存在超出我們建議的溫度範圍的環境，即不要低於 -30°C (-22°F) 或高於 70°C (158°F)，否則可能會損壞設備。
16. **注意：**如果電池放置不正確，將有爆炸的危險。因此，只可以使用製造商推薦的同一種或者同等型號的電池進行替換。請按照製造商的指示處理舊電池。
17. 根據 IEC 704-1:1982 的規定，操作員所在位置的音量不可高於 70dB(A)。
18. 限制區域：請勿將設備安裝於限制區域使用。
19. **免責聲明：**該安全指示符合 IEC 704-1 的要求。研華公司對其內容的準確性不承擔任何法律責任。
20. 使用過度恐傷害視力。
21. 使用 30 分鐘請休息 10 分鐘。
22. 未滿 2 歲幼兒不看螢幕，2 歲以上每天看螢幕不要超過 1 小時。
23. 本產品為國內裝置使用時，其電源僅限使用架構電源模組所提供電源直流輸入，不得使用交流電源及附加其他電源轉換裝置提供電源這者，其電源輸入電壓及電流請依說明書規定使用。

Wichtige Sicherheitshinweise

1. Bitte lesen sie Sich diese Hinweise sorgfältig durch.
2. Heben Sie diese Anleitung für den späteren Gebrauch auf.
3. Vor jedem Reinigen ist das Gerät vom Stromnetz zu trennen. Verwenden Sie Keine Flüssig-oder Aerosolreiniger. Am besten dient ein angefeuchtetes Tuch zur Reinigung.
4. Die NetzanschlUBsteckdose soll nahe dem Gerät angebracht und leicht zugänglich sein.
5. Das Gerät ist vor Feuchtigkeit zu schützen.
6. Bei der Aufstellung des Gerätes ist auf sicheren Stand zu achten. Ein Kippen oder Fallen könnte Verletzungen hervorrufen.
7. Die Belüftungsöffnungen dienen zur Luftzirkulation die das Gerät vor überhitzung schützt. Sorgen Sie dafür, daB diese Öffnungen nicht abgedeckt werden.
8. Beachten Sie beim. AnschluB an das Stromnetz die AnschluBwerte.
9. Verlegen Sie die NetzanschlUBleitung so, daB niemand darüber fallen kann. Es sollte auch nichts auf der Leitung abgestellt werden.
10. Es sollte auch nichts auf der Leitung abgestellt werden. Alle Hinweise und Warnungen die sich am Ger?ten befinden sind zu beachten.
11. Wird das Gerät über einen längeren Zeitraum nicht benutzt, sollten Sie es vom Stromnetz trennen. Somit wird im Falle einer Überspannung eine Beschädigung vermieden.
12. Durch die Lüftungsöffnungen dürfen niemals Gegenstände oder Flüssigkeiten in das Gerät gelangen. Dies könnte einen Brand bzw. elektrischen Schlag auslösen.
13. Öffnen Sie niemals das Gerät. Das Gerät darf aus Gründen der elektrischen Sicherheit nur von autorisiertem Servicepersonal geöffnet werden.
14. Wenn folgende Situationen auftreten ist das Gerät vom Stromnetz zu trennen und von einer qualifizierten Servicestelle zu überprüfen:
 - Netzkabel oder Netzstecker sind beschädigt.
 - Flüssigkeit ist in das Gerät eingedrungen.
 - Das Gerät war Feuchtigkeit ausgesetzt.
 - Wenn das Gerät nicht der Bedienungsanleitung entsprechend funktioniert oder Sie mit Hilfe dieser Anleitung keine Verbesserung erzielen.
15. VOSICHT: Explisionsgefahr bei unsachgemaben Austausch der Batterie.Ersatz nur durch denselben oder einem vom Hersteller empfohlene-mahnlichen Typ. Entsorgung gebrauchter Batterien navh Angaben des Herstellers.
16. ACHTUNG: Es besteht die Explosionsgefahr, falls die Batterie auf nicht fachmännische Weise gewechselt wird. Verfangan Sie die Batterie nur gleicher oder entsprechender Type, wie vom Hersteller empfohlen. Entsorgen Sie Batterien nach Anweisung des Herstellers.
17. Der arbeitsplatzbezogene Schalldruckpegel nach DIN 45 635 Teil 1000 beträgt 70dB(A) oder weiger.
18. Haftungsausschluss: Die Bedienungsanleitungen wurden entsprechend der IEC-704-1 erstellt. Advantech lehnt jegliche Verantwortung für die Richtigkeit der in die- sem Zusammenhang getätigten Aussagen ab.
19. Assurez-vous que la tension de la source d'alimentation est correcte avant de connecter l'équipement à la prise de courant. Au moyen d'un cordon d'alimentation connecté à une prise de courant avec mise à la terre.
20. Attention: Le fil du conducteur de liaison de protection doit être vert et jaune, 22AWG/0,3 mm² minimum.

Safety Precaution - Static Electricity

Follow these simple precautions to protect yourself from harm and the products from damage.

- To avoid electrical shock, always disconnect the power from the PC chassis before manual handling. Do not touch any components on the CPU card or other cards while the PC is powered on.
- Disconnect the power before making any configuration changes. A sudden rush of power after connecting a jumper or installing a card may damage sensitive electronic components.

Contents

Chapter 1	General Information	1
1.1	Introduction	2
1.1.1	Accessories Ordering P/N.....	2
1.2	Specifications	3
1.2.1	System Kernel.....	3
1.2.2	Communication Interface	3
1.2.3	LCD Panel.....	3
	Table 1.1: LCD panel.....	3
1.2.4	Touchscreen	3
1.2.5	Environment.....	4
1.2.6	EMC and Safety.....	4
1.2.7	Power.....	4
1.2.8	External I/O.....	4
1.3	Mounting	5
	Table 1.2: Panel mounting.....	5
	Table 1.3: Panel mounting.....	5
Chapter 2	System Setup.....	9
2.1	Transport and Unpacking.....	10
2.2	System Configuration.....	10
	Table 2.1: Boot mode: option (SW2)	11
	Table 2.2: 7"	11
	Table 2.3: 10"	11
	Table 2.4: AT/ATX (SW1).....	11
2.3	M.2 Key-E 2230 Express	12
2.3.1	M.2 Card Installation	12
2.4	System Power on	12
2.4.1	Embedding the TPC-100WX System and Earth Grounding Setup. 13	
2.5	Power/Digital Ground and Earth/Ground	15
Appendix A	Pin Assignments	17
A.1	M.2 Slot (E-Key).....	18
	Table A.1: 8.5mm half size 75 pin M.2 slot (E-Key).....	18
A.2	COM Port	19
	Table A.2: 9-Pin COM port connector (COM1)	19
	Table A.3: 9-Pin COM port connector (COM2/CAN)	19
	Table A.4: CAN BUS terminal (CN2)	20
	Table A.5: COM2 terminal (CN4).....	20

Chapter 1

General Information

1.1 Introduction

The TPC-100WX series is designed to excel in harsh industrial environments, offering a robust and compact solution for outdoor and demanding applications. With its NXP® Cortex®-A53 i.MX8M Mini quad-core processor, it delivers efficient processing power while maintaining energy efficiency. The 7"/10.1" TFT LCD display paired with a multi-touch glass sensor provides an intuitive user interface for control and monitoring applications. The wide operating temperature range of **-30 ~ 70°C (-22 ~ 158°F)** ensures that the TPC-100WX can function in both extremely cold and hot conditions, making it ideal for outdoor installations or heavy-duty industrial setups. Also, The TPC-100WX is well-equipped for web-based operations with two 10/100/1000 LAN ports, allowing for reliable and fast network connections.

Additionally, the TPC-100WX supports multiple operating systems, including **Linux Yocto** and **Android**, providing flexibility for developers and ensuring that the system can be easily tailored to a wide range of applications. Whether for industrial automation, energy management, or transportation systems, this multi-OS support ensures adaptability and ease of deployment across different software environments.

- NXP® ARM Cortex®-A53 i.MX8M Mini Quad core processor
- 7" 16:9 WSVGA LCD wide screen with PCAP multi-touch
- 10.1" 16:9 WXGA LCD wide screen with PCAP multi-touch
- Up to 4GB LPDDR4 RAM & 32GB eMMC storage onboard
- 10/100/1000 Mbps LAN
- 1MB FRAM backup memory for power interruption situation
- 2 x Serial port with termination resistor 120Ω that one supports CAN 2.0B protocol specification and programmable bit rate up to 1 Mb/sec
- Yocto3.3 version supports Optional M.2 Wifi, Bluetooth, TPM.2.0 module expansion support
- Android 13 version supports Optional M.2 WiFi module expansion support
- Panel mounting with true-flat IP66 front panel support
- -30 ~ 70° C wide operating temperature range

1.1.1 Accessories Ordering P/N

- **M.2 Key-E 2230 Express Module:** 98R4T100W01

1.2 Specifications

1.2.1 System Kernel

- **CPU:** NXP® ARM Cortex®-A53 i.MX8 Mini Quad Core 1.6 GHz Processor
- **Memory:** Quad Core: 4GB DDR4 RAM on board
- **Storage Memory:** 32GB eMMC on board; 1MB FRAM for data backup
- **Watchdog Timer:** Programmable as 1 second

1.2.2 Communication Interface

- **Serial Port:**
 - 1 x RS-232/422/485 (COM 1)
 - 1 x selectable mode for RS485 and CAN 2.0 B
- **LAN Port:** 2 x RJ45 with 10/100/1000 Mbps LAN
- **Others:**
 - 1 x USB 2.0 Micro USB Client
 - 2 x USB 2.0 Type-A Host 1 x Micro SD (Internal)
 - 1 x M.2 Key-E 2230 (Wi-fi/BT)

1.2.3 LCD Panel

Table 1.1: LCD panel			
Category	Item	7"	10.1"
LCD	Display Type	WSGA TFT LCD	WXGA TFT LCD
	Max. Resolution	800 x 480	1280 x 800
	Aspect Ratio	16:9	16:10
	Max. Color	16.7 M	16.2M
	Luminance (cd/m ²)	1000 nits	1200 nits
	Viewing Angle (H/V°)	170/170	170/170
	Backlight Life	50,000hrs	50,000hrs
	Contrast Ratio	800:1	800:1
Touch	Type	Projected capacitive	Projected capacitive
	Transmission	88% ± 2%	88% ± 2%
System Temperature	Operating	-30 ~ 70 °C (-22 ~ 158 °F)	-30 ~ 70 °C (-22 ~ 158 °F)
	Storage	-30 ~ 85 °C (-22 ~ 185°F)	-30 ~ 85 °C (-22 ~ 185 °F)

1.2.4 Touchscreen

- **Touch Points:** 10 Points
- **Light Transmission:** above 85%
- **Pencil Hardness:** 7H
- **Type:** Projected capacitive (P-CAP) touch

1.3 Mounting

■ VESA Mount

The TPC-100WX rear cover features four VESA mounting (100 x 100 mm) holes. The VESA mounting kit needs to be installed by 4pcs M4x10L screws. Please use suitable mounting apparatus to avoid risk of injury.

■ Panel Mount

There is an adhesive waterproof gasket on the front bezel. Make sure the waterproof gasket is in position before installing a TPC-100WX panel computer into the panel opening.

1. Install the TPC into the panel opening.
2. Find the six clamps and six long screws in the accessory pack. Hook the clamps to the holes around the four sides of the bezel. Insert the screws into every clamp and fasten them. These screws will push the mounting panel and fix the unit.
3. The suggested mounting panel thickness is less than 6 mm (0.236").

Table 1.2: Panel mounting

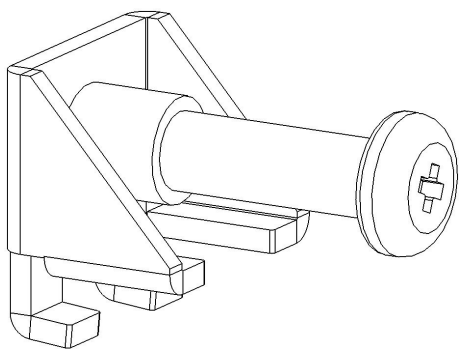

Insert the screws into each clamp and tighten them to fasten the clamp in place.

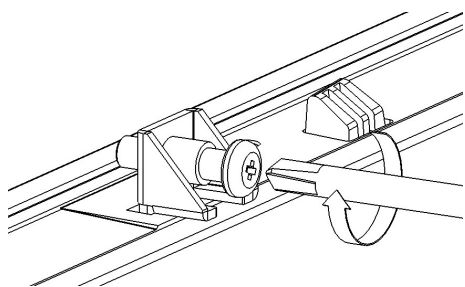

Hook the clamp into the holes and fasten the screws (Torque: 5 kgf-cm)
These screws will push the mounting panel and secure the unit.

Table 1.3: Panel mounting

Size	W7	W10
Screw (M4 x 25mm) & Clamper Q'ty	4	8

Dimensions and Cutout

TPC-107WX

Unit: mm

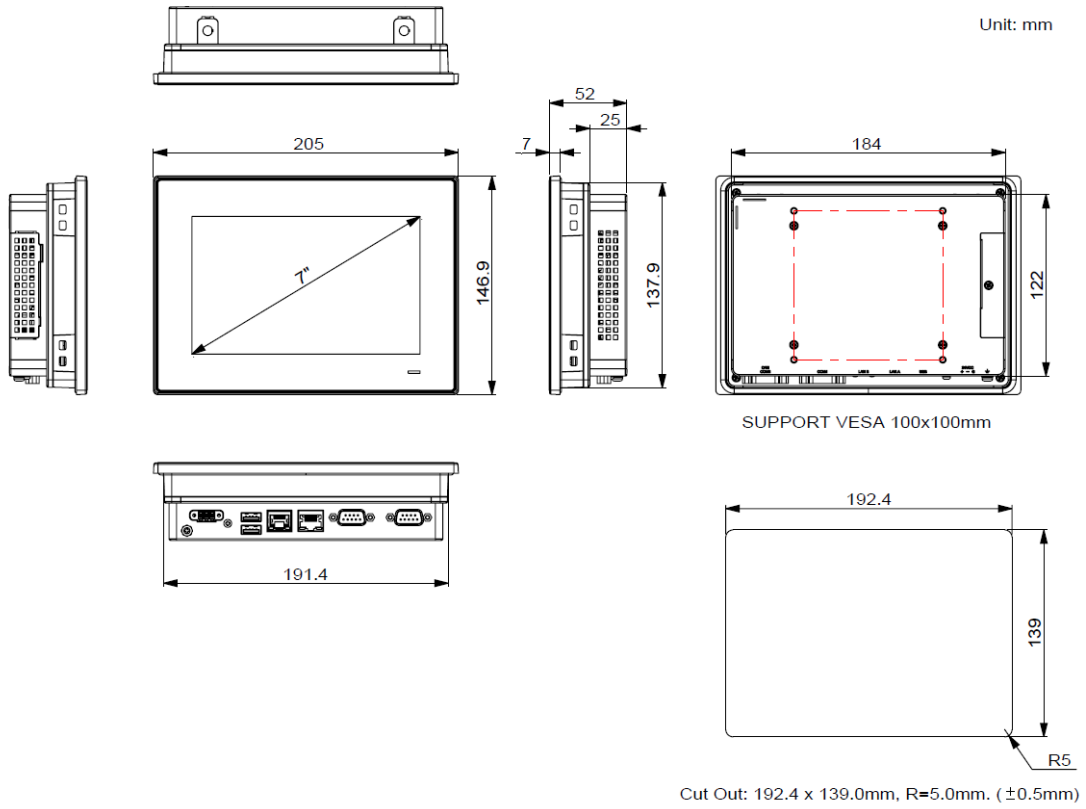

TPC-110WX

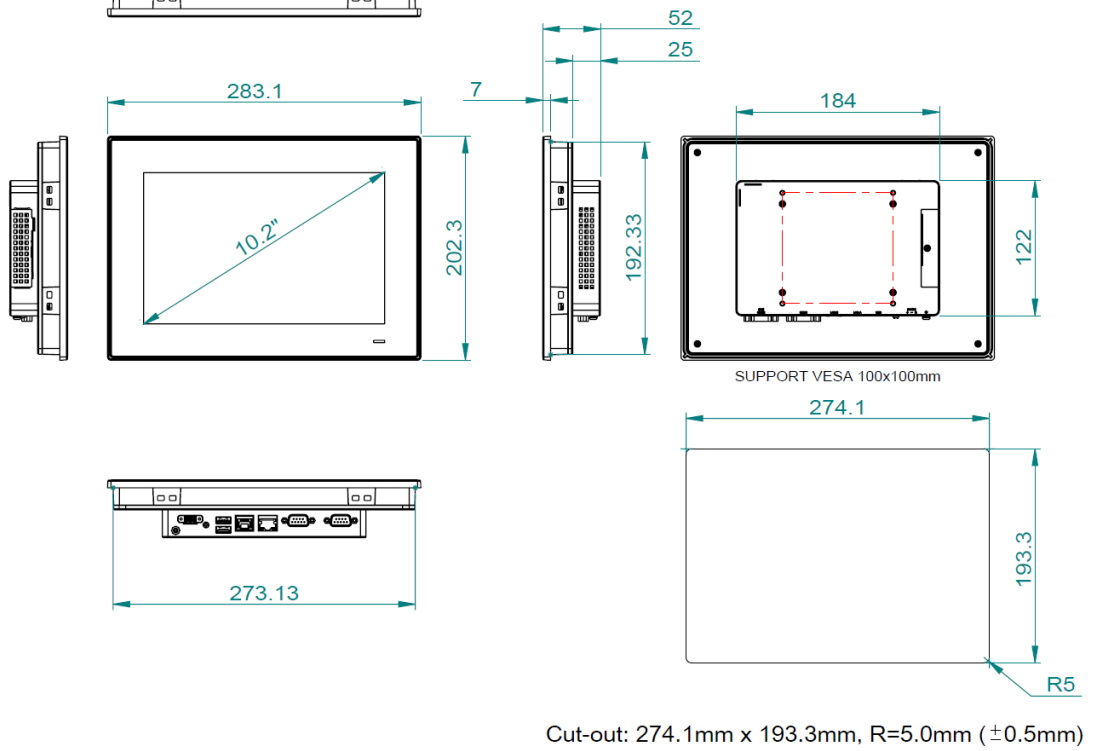

LED Indicator

Off - "dark"

ON - "Blue"

Standby - "orange"

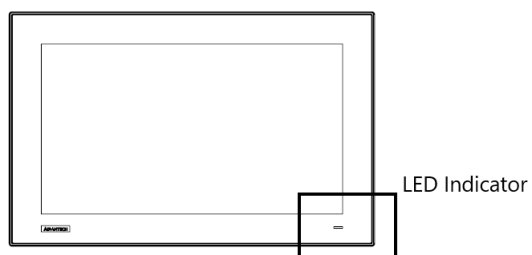

Chapter 2

System Setup

2.1 Transport and Unpacking

When accepting a delivery, please check the packaging for visible transportation damage and check the delivery for completeness by comparing it with your order form. If you notice any shipping damage or inconsistencies between the contents and your order, please inform the responsible delivery service immediately. During transportation, the TPC system should be protected from excessive mechanical stress. If the TPC system is transported or stored without packaging, shocks, vibrations, pressure, and moisture may impact the unprotected unit. Additionally, damaged packaging indicates that ambient conditions have already had a massive impact on the device. Therefore, please use the original packaging during transportation and storage. If the TPC system is transported in cold weather or is exposed to extreme variations in temperature ensure that moisture (condensation) does not build up on or inside the HMI device. Moisture can result in short circuits and damage to the device. To avoid this, store the TPC system in a dry environment and bring the system to room temperature before powering it up. If condensation occurs, a delay time of approximately 12 hours must be allowed to ensure that the system is completely dry before being switched on.

2.2 System Configuration

TPC-100WX is a compact touch panel with IIoT functions for industrial applications. The system setup will be completed by the dealer or system integrator prior to delivery. However, users may still need to access the system to adjust configuration, such as the interface or boot modes. Before powering on, please open the SD & micro USB cover and select the correct mode. Configuration can be set via the switch on the TPC- 100W rear board as shown below.

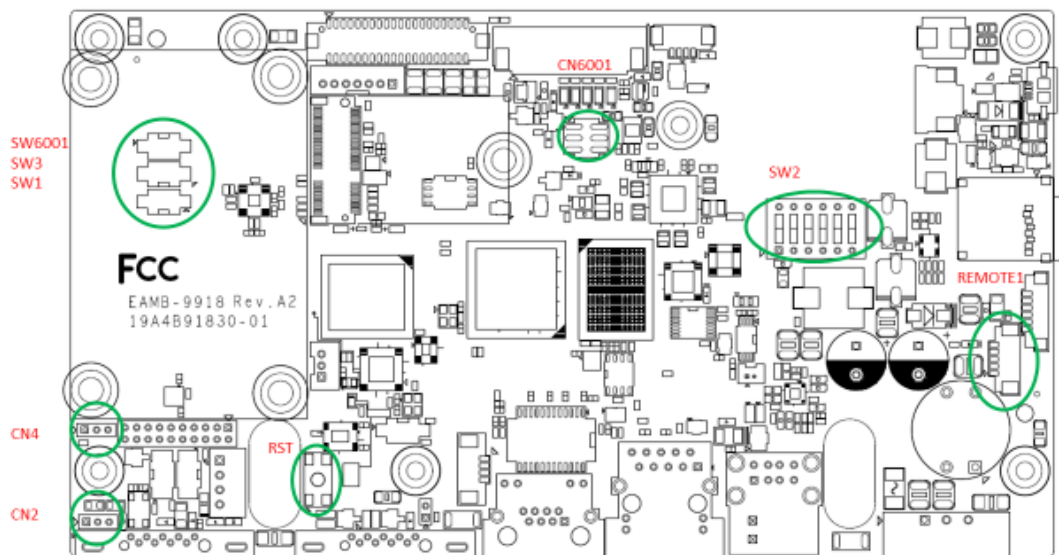

The default setting is RS232 mode and eMMC Boot. Kindly refer to the following pin definition table for mode switch.

Table 2.1: Boot mode: option (SW2)



SD boot (Install image) 1.OFF 2.ON 3.ON	
eMMC boot default 1.ON 2.OFF 3.OFF	

Table 2.2: 7"

CN6001 CN6001(1-3,2-4)	
SW6001 1.ON 2.OFF	

Table 2.3: 10"

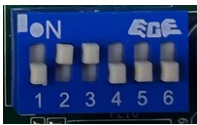
CN6001 CN6001(3-5,4-6)	
SW6001 1.ON 2.OFF	

Table 2.4: AT/ATX (SW1)

AT 2.ON 1.OFF	
ATX 2.OFF 1.ON	

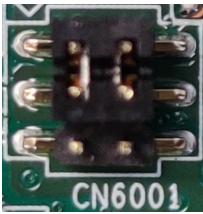
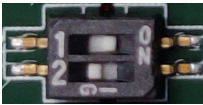
2.3 M.2 Key-E 2230 Express

2.3.1 M.2 Card Installation

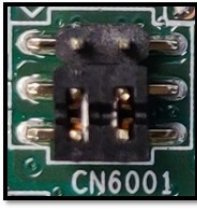
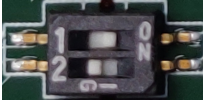
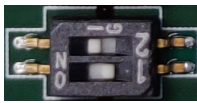
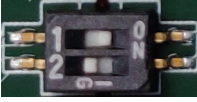
TPC-100WX provides M.2 key Express slot and allows users to expend functions like Wi-Fi and Bluetooth type modules. Open the rear bracket and configure the M.2 module. (Refer to Appendix A1 for the detailed M.2 Slot E-Key).

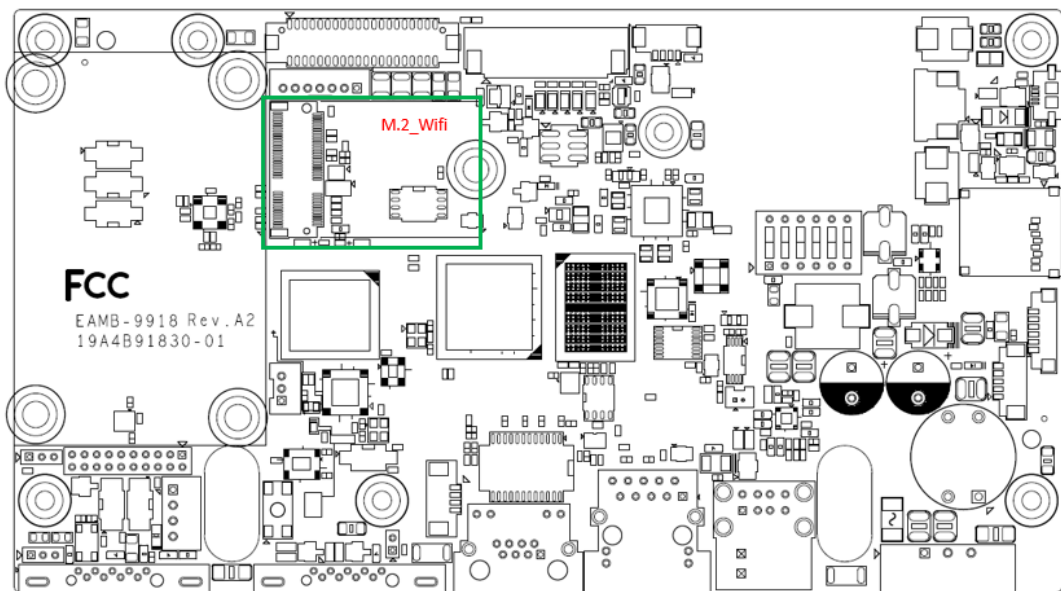

2.4 System Power on

A 2-pin power connector is included in the accessory box. Connect the power connector to Vdc power lines and plug the power lines into the system power receptor.

The product is intended to be supplied by an UL Listed power supply suitable for use at Tma 60°C min. whose output meets PS2(or LPS), ES1(or SELV) output is rated: 24Vdc, 0.83A min. or 24Vdc, 1.2A min. to match the unit rating or output is rated: 48Vdc, 0.53A min. for PoE input. Please contact Advantech for further information.

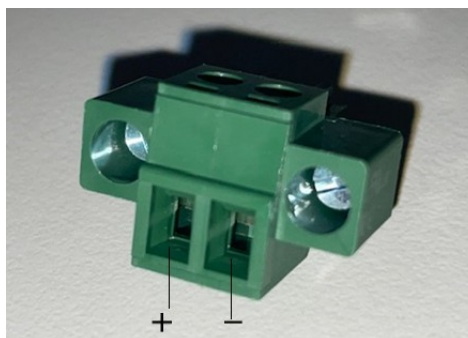

The terminal block is suitable for 16~26 AWG(10A). Torque value 2.5 lb-in. User copper conductors only. Must be installed by skilled person.

Warning! *The system may get damaged when the power is turned on and the power source is not connected to the correct pins.*



Le système peut être endommagé lors de la mise sous tension et la source d'alimentation n'est pas connectée aux bonnes broches.

2.4.1 Embedding the TPC-100WX System and Earth Grounding Setup

Follow the following steps to setup TPC-100WX system, and please pay attention that Ground pin of TPC-100W system should be connected to earth ground. Under this circumstance, TPC-100W system could have the best performance such as EMI immunity, ESD immunity, Surge immunity and also system isolation. If the TPC-100WX system is embedded in the cabinet, the TPC-100WX system's ground, cabinet's ground and earth ground should be connected together.

1. Install the TPC-100W system into the cabinet.

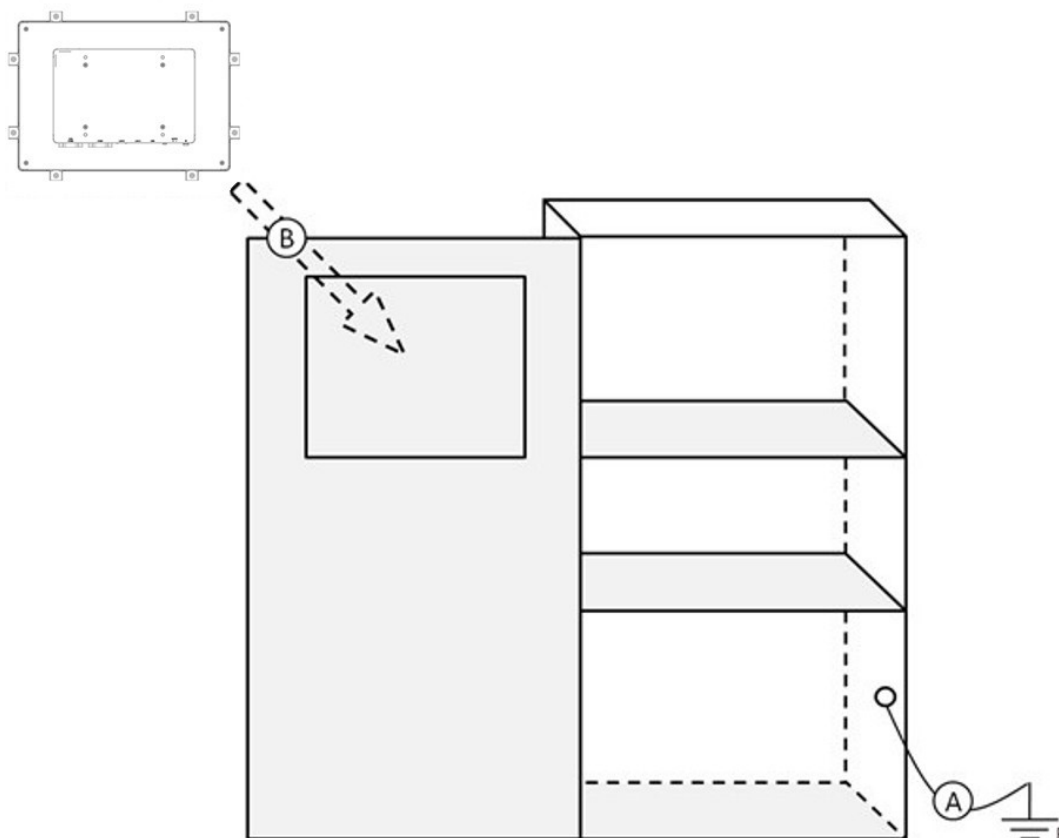

A: Connect the cabinet to earth ground.

B: Embed the TPC-100WX system into the cabinet without any I/O cable and power.

2.5 Power/Digital Ground and Earth/Ground

The power/digital ground blocks external electrical interference to the chassis, thereby ensuring that bad grounding does not cause electric shocks. This is known as Level 1 isolation, which is not typically implemented in consumer-grade devices.

- TPC chassis and ground (Power Pin 3) are short.
- TPC chassis and power/digital ground are open.

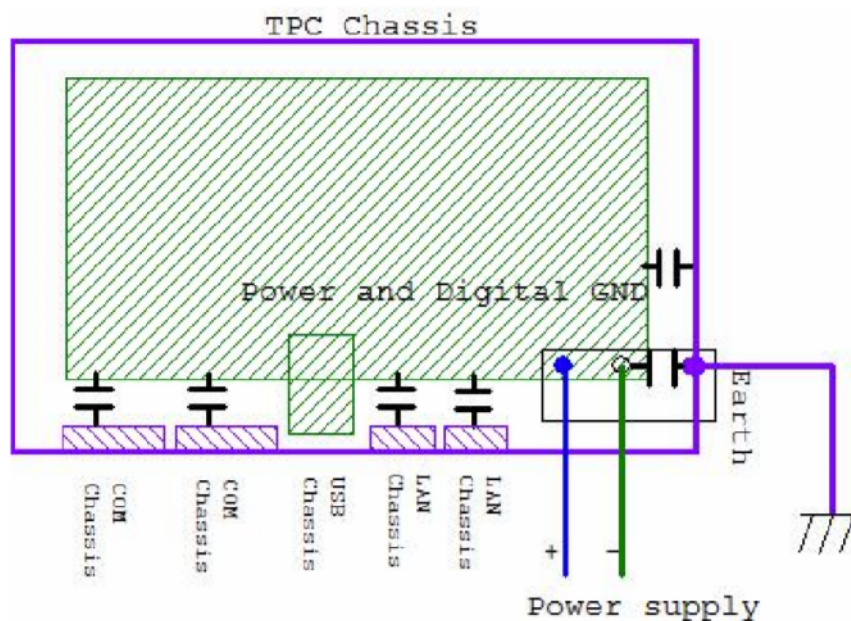

The TPC devices are industrial-grade products. The hardware is designed to protect against external interference and eliminate the risk of electric shock. To ensure isolation protection, the following must be considered:

- The Ethernet connection is isolated. LAN connections will not affect the isolation design.
- General USB devices are built to minimize EMI and ESD issues, such as a chassis or digital short. The TPC devices block EMI and ESD, protecting USB devices from damage. The devices are designed to use Power GND as a vent path to ensure Power GND and Chassis GND do not differ abnormally.
- For various COM port designs, long-distance connections can cause voltage differences between the two COM port chassis. Therefore, the shell ground of the cable must be isolated to the signal digital ground.

Use of a third-party device or cable can disrupt Level 1 isolation. In such circumstances, users should short all grounds (Power GND/Digital GND/Earth GND) and ensure adequate earth/ground connection.

Appendix **A**

Pin Assignments

A.1 M.2 Slot (E-Key)

Table A.1: 8.5mm half size 75 pin M.2 slot (E-Key)

Pin	Signal	Description	Pin	Signal	Description
1	GND		2	+3.3V	
3	USB+	USB serial data interface compliant to the USB 2.0 specification	4	+3.3V	
5	USB-		6	Reserved	NC
7	GND		8	PCM_BCLK	PCM is another 4 wire interface, very similar to I2S, which can support a more flexible protocol. It has bit clock (BCLK) and sync (SYNC) lines that are used to synchronise the link while the Tx and Rx lines are used to transmit and receive the audio data.
9	SDIO_CLK	10	PCM_SYNC		
11	SDIO_CMD	12	PCM_OUT		
13	SDIO_DATA0	Secure Digital Input Output, a type of Secure Digital card interface. It can be used as an interface for input or output devices.	14	PCM_IN	
15	SDIO_DATA1		16	Reserved	NC
17	SDIO_DATA2		18	GND	
19	SDIO_DATA3		20	Reserved	NC
21	SDIO_WAKE#		22	Reserved	NC
23	SDIO_RESET#				
33	GND		32	Reserved	NC
35	Reserved	NC	34	Reserved	NC
37	Reserved	NC	36	Reserved	NC
39	GND		38	Reserved	NC
41	Reserved	NC	40	Reserved	NC
43	Reserved	NC	42	Reserved	NC
45	GND		44	Reserved	NC
47	Reserved	NC	46	Reserved	NC
49	Reserved	NC	48	Reserved	NC
51	GND		50	SYSClk	
53	Reserved	NC	52	RESET#	Functional reset to the card
55	Reserved	NC	54	Reserved	NC
57	GND		56	Reserved	NC
59	Reserved	NC	58	I2C_DATA	
61	Reserved	NC	60	I2C_CLK	
63	GND		62	Reserved	NC
65	Reserved	NC	64	Reserved	NC
67	Reserved	NC	66	Reserved	NC
69	GND		68	Reserved	NC
71	Reserved	NC	70	Reserved	NC
73	Reserved	NC	72	+3.3V	
75	GND		74	+3.3V	

A.2 COM Port

- 9-Pin COM Port Connector (COM1)

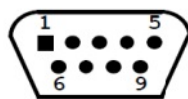

Table A.2: 9-Pin COM port connector (COM1)

Pin	RS232	RS422	RS485
1	-	TX-	D-
2	RX	TX+	D+
3	TX	RX+	-
4	-	RX-	-
5	GND	GND	GND
6	-	-	-
7	RTS	-	-
8	CTS	-	-
9	-	-	-

- 9-Pin COM Port Connector (COM2/CAN)

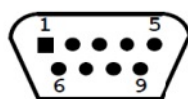

Table A.3: 9-Pin COM port connector (COM2/CAN)

Pin	RS485	CAN
1	D-	-
2	D+	-
3	-	-
4	-	L
5	GND	-
6	-	-
7	-	-
8	-	GND (isolation)
9	-	H

CAN BUS

Pin define



COM2
Pin define

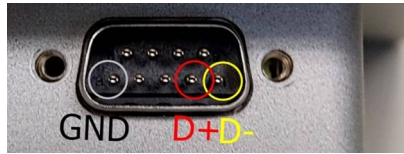

Table A.4: CAN BUS terminal (CN2)



CN2 (1-2)	
CN2 (2-3) 120 ohm terminal default	

Table A.5: COM2 terminal (CN4)

CN4 (1-2) default	
CN4 (2-3) 120 ohm terminal	

www.advantech.com

Please verify specifications before quoting. This guide is intended for reference purposes only.

All product specifications are subject to change without notice.

No part of this publication may be reproduced in any form or by any means, such as electronically, by photocopying, recording, or otherwise, without prior written permission from the publisher.

All brand and product names are trademarks or registered trademarks of their respective companies.

© Advantech Co., Ltd. 2025