

User Manual

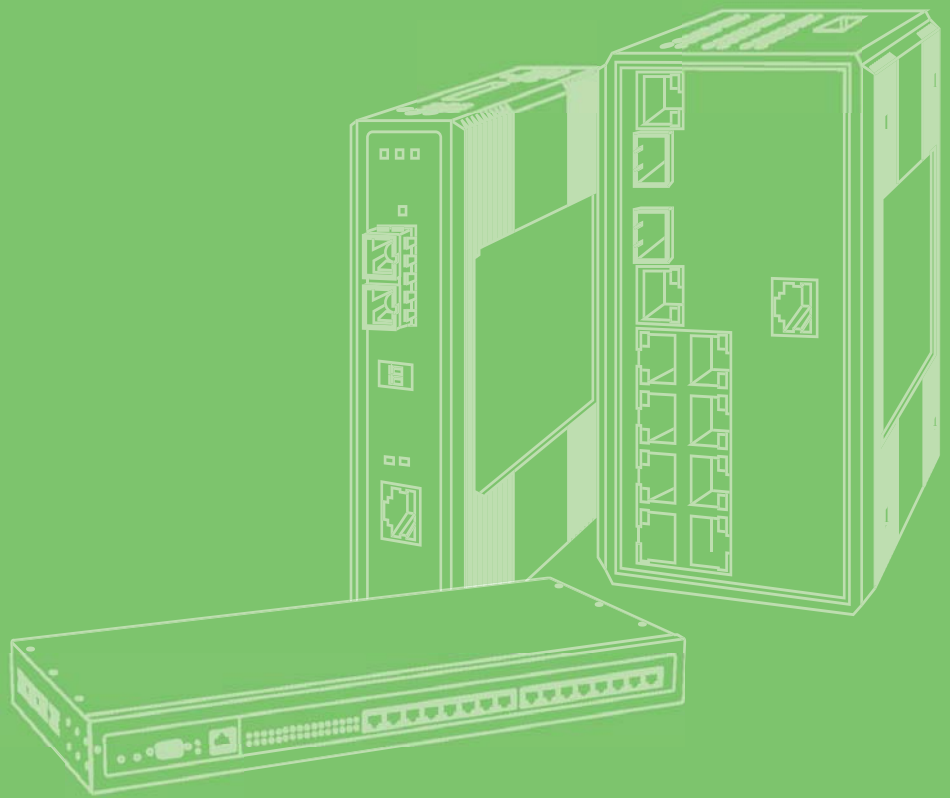

EKI-5729PI & EKI-5624PI

ProView Series Ethernet
Switches

ADVANTECH

Enabling an Intelligent Planet

Copyright

The documentation and the software included with this product are copyrighted 2016 by Advantech Co., Ltd. All rights are reserved. Advantech Co., Ltd. reserves the right to make improvements in the products described in this manual at any time without notice. No part of this manual may be reproduced, copied, translated or transmitted in any form or by any means without the prior written permission of Advantech Co., Ltd. Information provided in this manual is intended to be accurate and reliable. However, Advantech Co., Ltd. assumes no responsibility for its use, nor for any infringements of the rights of third parties, which may result from its use.

Acknowledgements

Intel and Pentium are trademarks of Intel Corporation.

Microsoft Windows and MS-DOS are registered trademarks of Microsoft Corp.

All other product names or trademarks are properties of their respective owners.

Product Warranty (5 years)

Advantech warrants to you, the original purchaser, that each of its products will be free from defects in materials and workmanship for five years from the date of purchase.

This warranty does not apply to any products which have been repaired or altered by persons other than repair personnel authorized by Advantech, or which have been subject to misuse, abuse, accident or improper installation. Advantech assumes no liability under the terms of this warranty as a consequence of such events.

Because of Advantech's high quality-control standards and rigorous testing, most of our customers never need to use our repair service. If an Advantech product is defective, it will be repaired or replaced at no charge during the warranty period. For out-of-warranty repairs, you will be billed according to the cost of replacement materials, service time and freight. Please consult your dealer for more details.

If you think you have a defective product, follow these steps:

1. Collect all the information about the problem encountered. (For example, CPU speed, Advantech products used, other hardware and software used, etc.) Note anything abnormal and list any onscreen messages you get when the problem occurs.
2. Call your dealer and describe the problem. Please have your manual, product, and any helpful information readily available.
3. If your product is diagnosed as defective, obtain an RMA (return merchandise authorization) number from your dealer. This allows us to process your return more quickly.
4. Carefully pack the defective product, a fully-completed Repair and Replacement Order Card and a photocopy proof of purchase date (such as your sales receipt) in a shippable container. A product returned without proof of the purchase date is not eligible for warranty service.
5. Write the RMA number visibly on the outside of the package and ship it prepaid to your dealer.

Part No. XXXXXXXXXXXX

Printed in Taiwan

Edition 1

July 2016

Declaration of Conformity

CE

This product has passed the CE test for environmental specifications when shielded cables are used for external wiring. We recommend the use of shielded cables. This kind of cable is available from Advantech. Please contact your local supplier for ordering information.

This product has passed the CE test for environmental specifications. Test conditions for passing included the equipment being operated within an industrial enclosure. In order to protect the product from being damaged by ESD (Electrostatic Discharge) and EMI leakage, we strongly recommend the use of CE-compliant industrial enclosure products.

FCC Class A

Note: This equipment has been tested and found to comply with the limits for a Class A digital device, pursuant to part 15 of the FCC Rules. These limits are designed to provide reasonable protection against harmful interference when the equipment is operated in a commercial environment. This equipment generates, uses, and can radiate radio frequency energy and, if not installed and used in accordance with the instruction manual, may cause harmful interference to radio communications. Operation of this equipment in a residential area is likely to cause harmful interference in which case the user will be required to correct the interference at his own expense.

Technical Support and Assistance

1. Visit the Advantech web site at www.advantech.com/support where you can find the latest information about the product.
2. Contact your distributor, sales representative, or Advantech's customer service center for technical support if you need additional assistance. Please have the following information ready before you call:
 - Product name and serial number
 - Description of your peripheral attachments
 - Description of your software (operating system, version, application software, etc.)
 - A complete description of the problem
 - The exact wording of any error messages

Warnings, Cautions and Notes

Warning! *Warnings indicate conditions, which if not observed, can cause personal injury!*



Caution! *Cautions are included to help you avoid damaging hardware or losing data. e.g.*



There is a danger of a new battery exploding if it is incorrectly installed. Do not attempt to recharge, force open, or heat the battery. Replace the battery only with the same or equivalent type recommended by the manufacturer. Discard used batteries according to the manufacturer's instructions.

Note! *Notes provide optional additional information.*



Document Feedback

To assist us in making improvements to this manual, we would welcome comments and constructive criticism. Please send all such - in writing to: support@advantech.com

Packing List

Before setting up the system, check that the items listed below are included and in good condition. If any item does not accord with the table, please contact your dealer immediately.

- 1 x Industrial Ethernet Switch
- 1 x Wall-mounting Bracket
- 1 x DIN-Rail mounting Bracket and Screws
- 1 x EKI Device Configuration Utility CD-ROM
- 1 x Startup Manual

Safety Instructions

1. Read these safety instructions carefully.
2. Keep this User Manual for later reference.
3. Disconnect this equipment from any AC outlet before cleaning. Use a damp cloth. Do not use liquid or spray detergents for cleaning.
4. For plug-in equipment, the power outlet socket must be located near the equipment and must be easily accessible.
5. Keep this equipment away from humidity.
6. Put this equipment on a reliable surface during installation. Dropping it or letting it fall may cause damage.
7. The openings on the enclosure are for air convection. Protect the equipment from overheating. **DO NOT COVER THE OPENINGS.**
8. Make sure the voltage of the power source is correct before connecting the equipment to the power outlet.
9. Position the power cord so that people cannot step on it. Do not place anything over the power cord.
10. All cautions and warnings on the equipment should be noted.
11. If the equipment is not used for a long time, disconnect it from the power source to avoid damage by transient overvoltage.
12. Never pour any liquid into an opening. This may cause fire or electrical shock.

13. Never open the equipment. For safety reasons, the equipment should be opened only by qualified service personnel.
14. If one of the following situations arises, get the equipment checked by service personnel:
 15. The power cord or plug is damaged.
 16. Liquid has penetrated into the equipment.
 17. The equipment has been exposed to moisture.
 18. The equipment does not work well, or you cannot get it to work according to the user's manual.
 19. The equipment has been dropped and damaged.
 20. The equipment has obvious signs of breakage.
21. **DO NOT LEAVE THIS EQUIPMENT IN AN ENVIRONMENT WHERE THE STORAGE TEMPERATURE MAY GO BELOW -20° C (-4° F) OR ABOVE 60° C (140° F). THIS COULD DAMAGE THE EQUIPMENT. THE EQUIPMENT SHOULD BE IN A CONTROLLED ENVIRONMENT.**
22. **CAUTION: DANGER OF EXPLOSION IF BATTERY IS INCORRECTLY REPLACED. REPLACE ONLY WITH THE SAME OR EQUIVALENT TYPE RECOMMENDED BY THE MANUFACTURER, DISCARD USED BATTERIES ACCORDING TO THE MANUFACTURER'S INSTRUCTIONS.**
23. The sound pressure level at the operator's position according to IEC 704-1:1982 is no more than 70 dB (A).

DISCLAIMER: This set of instructions is given according to IEC 704-1. Advantech disclaims all responsibility for the accuracy of any statements contained herein.

Wichtige Sicherheitshinweise

1. Bitte lesen sie Sich diese Hinweise sorgfältig durch.
2. Heben Sie diese Anleitung für den späteren Gebrauch auf.
3. Vor jedem Reinigen ist das Gerät vom Stromnetz zu trennen. Verwenden Sie Keine Flüssig-oder Aerosolreiniger. Am besten dient ein angefeuchtetes Tuch zur Reinigung.
4. Die NetzanschlUBsteckdose soll nahe dem Gerät angebracht und leicht zugänglich sein.
5. Das Gerät ist vor Feuchtigkeit zu schützen.
6. Bei der Aufstellung des Gerätes ist auf sicheren Stand zu achten. Ein Kippen oder Fallen könnte Verletzungen hervorrufen.
7. Die Belüftungsöffnungen dienen zur Luftzirkulation die das Gerät vor überhit-zung schützt. Sorgen Sie dafür, daB diese Öffnungen nicht abgedeckt werden.
8. Beachten Sie beim. AnschluB an das Stromnetz die AnschluBwerte.
9. Verlegen Sie die NetzanschlUBleitung so, daB niemand darüber fallen kann. Es sollte auch nichts auf der Leitung abgestellt werden.
10. Alle Hinweise und Warnungen die sich am Geräten befinden sind zu beachten.
11. Wird das Gerät über einen längeren Zeitraum nicht benutzt, sollten Sie es vom Stromnetz trennen. Somit wird im Falle einer Überspannung eine Beschädigung vermieden.
12. Durch die Lüftungsöffnungen dürfen niemals Gegenstände oder Flüssigkeiten in das Gerät gelangen. Dies könnte einen Brand bzw. elektrischen Schlag auslösen.
13. Öffnen Sie niemals das Gerät. Das Gerät darf aus Gründen der elektrischen Sicherheit nur von autorisiertem Servicepersonal geöffnet werden.
14. Wenn folgende Situationen auftreten ist das Gerät vom Stromnetz zu trennen und von einer qualifizierten Servicestelle zu überprüfen:
 15. Netzkabel oder Netzstecker sind beschädigt.
 16. Flüssigkeit ist in das Gerät eingedrungen.
 17. Das Gerät war Feuchtigkeit ausgesetzt.
 18. Wenn das Gerät nicht der Bedienungsanleitung entsprechend funktioniert oder Sie mit Hilfe dieser Anleitung keine Verbesserung erzielen.
 19. Das Gerät ist gefallen und/oder das Gehäuse ist beschädigt.
 20. Wenn das Gerät deutliche Anzeichen eines Defektes aufweist.
21. **VORSICHT:** Explosionsgefahr bei unsachgemaben Austausch der Batterie.Ersatz nur durch denselben oder einem vom Hersteller empfohlene-männlichen Typ. Entsorgung gebrauchter Batterien navh Angaben des Herstellers.
22. **ACHTUNG:** Es besteht die Explosionsgefahr, falls die Batterie auf nicht fach-männische Weise gewechselt wird. Verfangan Sie die Batterie nur gleicher oder entsprechender Type, wie vom Hersteller empfohlen. Entsorgen Sie Batterien nach Anweisung des Herstellers.
23. Der arbeitsplatzbezogene Schalldruckpegel nach DIN 45 635 Teil 1000 beträgt 70dB(A) oder weiger.

Haftungsausschluss: Die Bedienungsanleitungen wurden entsprechend der IEC-704-1 erstellt. Advantech lehnt jegliche Verantwortung für die Richtigkeit der in diesem Zusammenhang getätigten Aussagen ab.

Safety Precaution - Static Electricity

Follow these simple precautions to protect yourself from harm and the products from damage.

- To avoid electrical shock, always disconnect the power from your PC chassis before you work on it. Don't touch any components on the CPU card or other cards while the PC is on.
- Disconnect power before making any configuration changes. The sudden rush of power as you connect a jumper or install a card may damage sensitive electronic components.

Contents

Chapter 1	Product Overview	1
1.1	Specifications.....	2
1.2	Hardware Views.....	3
1.2.1	Front View.....	3
	Figure 1.1 Front View	3
	Figure 1.2 Front View	4
	Figure 1.3 System LED Panel	5
1.2.2	Rear View	6
	Figure 1.4 Rear View.....	6
1.2.3	Top View.....	7
	Figure 1.5 Top View	7
1.2.4	Bottom View.....	7
	Figure 1.6 Bottom View	7
Chapter 2	Switch Installation	8
2.1	Installation Guidelines.....	9
2.1.1	Connecting Hardware	9
2.2	Verifying Switch Operation.....	10
2.3	Installing the Switch	11
2.3.1	DIN Rail Mounting.....	11
	Figure 2.1 Installing the DIN-Rail Mounting Kit.....	11
	Figure 2.2 Removing the DIN-Rail.....	12
2.3.2	Wall-Mounting.....	12
	Figure 2.3 Installing Wall Mount Plates	13
	Figure 2.4 Securing Wall Mounting Screws.....	13
	Figure 2.5 Wall Mount Installation	14
2.4	Connecting the Switch to Ethernet Ports	15
2.4.1	RJ45 Ethernet Cable Wiring	15
	Figure 2.6 Ethernet Plug & Connector Pin Position.....	15
2.5	Power Supply Installation.....	16
2.5.1	Overview.....	16
	Figure 2.7 Power Wiring for EKI-5729PI & EKI-5624PI.....	16
2.5.2	Considerations.....	16
2.5.3	Grounding the Device	17
	Figure 2.8 Grounding Connection	17
2.5.4	Wiring a Relay Contact	18
	Figure 2.9 Terminal Receptor: Relay Contact for PoE models..	18
2.5.5	Wiring the Power Inputs.....	18
	Figure 2.10 Terminal Receptor: Power Input Contacts for PoE mod- els.....	18
	Figure 2.11 Removing a Terminal Block	19
	Figure 2.12 Installing DC Wires in a Terminal Block	19
	Figure 2.13 Securing a Terminal Block to a Receptor.....	20
Chapter 3	Configuration Utility	21
3.1	Overview	22
3.2	Enabling ProView Function.....	22
	Figure 3.1 Enabling ProView Features.....	23
3.3	Installing the Configuration Utility.....	23
	Figure 3.2 InstallShield Wizard 1 of 4.....	24
	Figure 3.3 InstallShield Wizard 2 of 4.....	24

	Figure 3.4 InstallShield Wizard 3 of 4	25
	Figure 3.5 InstallShield Wizard 4 of 4	25
3.4	Utility Menu Map	26
	Figure 3.6 Configuration Utility Overview	26
3.5	Menu Bar	27
3.5.1	View Menu	27
	Figure 3.7 View > Settings > Main Form Setting	27
	Figure 3.8 View > Settings > Device Manager	28
3.5.2	Management Menu	29
3.5.3	Help Menu	29
3.6	Tool Bar	29
3.7	TreeView	30
3.8	Information Panel	30
3.9	Status Bar	30
3.10	Configuration Area	30

Chapter 4 Managing Switch31

4.1	Discovering Switches	32
4.1.1	First Time Installation	32
	Figure 4.1 Selecting Networking Setting	32
	Figure 4.2 Configuring a Static IP Setting	33
4.1.2	Discovering Switches	34
	Figure 4.3 Auto Searching Screen	34
	Figure 4.4 Selecting Search Again	35
4.1.3	Group Management	35
	Figure 4.5 Adding a Group	36
	Figure 4.6 Adding a Switch to Favorites	37
	Figure 4.7 Add Favorite	38
	Figure 4.8 Add Favorite	39
4.1.4	Configuring the System	39
	Figure 4.9 Changing Device Name	40
	Figure 4.10 Setting Modbus/TCP Idle Time	41
	Figure 4.11 Setting SNMP	42
	Figure 4.12 Setting Modbus/TCP Idle Time	43
4.2	Modbus/TCP Mapping	44
4.2.1	Modbus/TCP Mapping Table	44

Chapter 1

Product Overview

1.1 Specifications

Specifications	Description		
Interface	I/O Port <ul style="list-style-type: none"> ■ EKI-5624PI: 4 x 10/100BaseT(X) with PoE + 2 x 10/100/1000BaseT(X) ■ EKI-5729PI: 8 x 10/100/1000BaseT(X) with PoE + 2 x 10/100/1000BaseT(X) 		
	Power Connector	6-pin screw Terminal Block (including relay)	
Physical	Enclosure	Metal Shell	
	Protection Class	IP30	
	Installation	DIN-Rail and Wall-Mount	
	Dimensions (W x H x D)	<ul style="list-style-type: none"> ■ EKI-5624PI: 74mm x 152mm x 105mm ■ EKI-5729PI: 74mm x 152mm x 105mm 	
LED Display	System LED	PWR1, PWR2, P-Fail, Loop detection, PoE	
	Port LED	Link / Speed / Activity / PoE	
Environment	Operating Temperature <ul style="list-style-type: none"> ■ Wide Temperature: -40°C ~ 75°C (-40°F ~ 167°F) ■ Standard Temperature: -25°C ~ 60°C(-4°F ~ 140°F) 		
	Storage Temperature	-40°C ~ 85° C (-40°F ~ 185° F)	
	Ambient Relative Humidity	10 ~ 95% (non-condensing)	
Switch Properties	MAC Address <ul style="list-style-type: none"> ■ EKI-5624PI: 2K entries ■ EKI-5729PI: 8K entries 		
Switch Properties	Switching Bandwidth <ul style="list-style-type: none"> ■ EKI-5624PI: 4.8Gbps ■ EKI-5729PI: 20Gbps 		
Power	Power Consumption <ul style="list-style-type: none"> ■ EKI-5624PI: 60 watts ■ EKI-5729PI: 65 watts 		
	Power Input	12V ~ 24V (7A ~ 3A)	
Certifications	Safety <ul style="list-style-type: none"> ■ IEC/EN 60950-1 ■ UL61010-1+UL61010-2-201 		
	EMC	CE, FCC, E-Mark	
	EMI	EN 55011/ 55022 Class A, EN 61000-6-4, FCC Part 15 Subpart B Class A	
	EMS	<ul style="list-style-type: none"> ■ EN 55024/ EN 61000-6-2 ■ EN 61000-4-2 (ESD) ■ EN 61000-4-3 (RS) ■ EN 61000-4-4 (EFT) ■ EN 61000-4-5 (Surge) ■ EN 61000-4-6 (CS) ■ EN 61000-4-8 (Magnetic Field) 	
		Shock	IEC 60068-2-27
		Freefall	IEC 60068-2-32
		Vibration	IEC 60068-2-6

1.2 Hardware Views

1.2.1 Front View

The following view applies to EKI-5624PI.

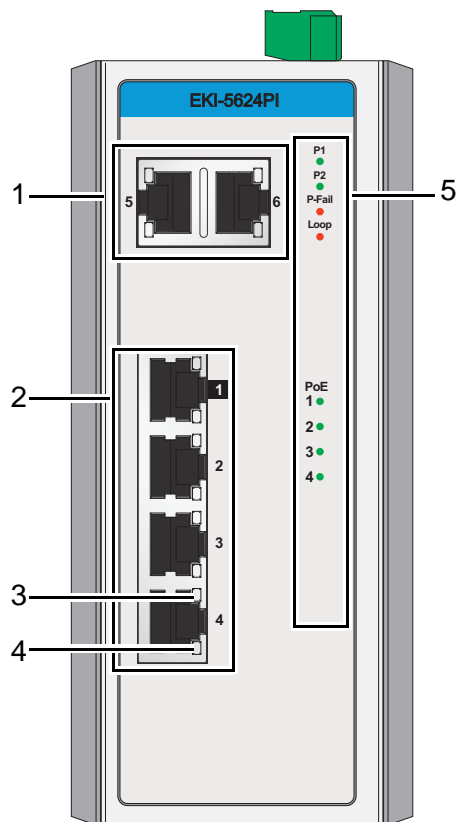

Figure 1.1 Front View

No.	Item	Description
	ETH port	Two 10/100/1000BaseT(X) ports.
	ETH port	Four 10/100BaseT(X) with PoE ports.
	LNK/ACT LED	Link activity LED.
	Speed LED	■ Fast Ethernet: ■ Amber: 100M ■ Off: 10M
	System LED panel	See "System LED Panel" on page 5 for further details.

The following view applies to EKI-5729PI.

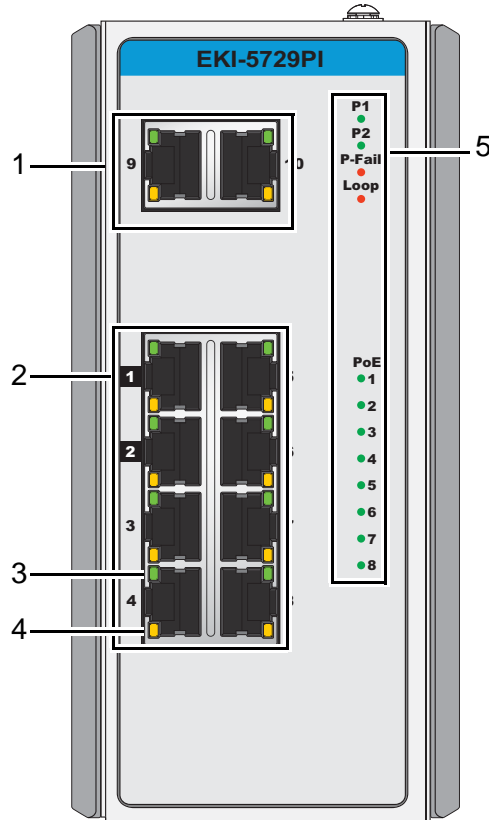

Figure 1.2 Front View

No.	Item	Description
	ETH port	Two 10/100/1000BaseT(X) ports.
	ETH port	Eight 10/100/1000BaseT(X) with PoE ports.
	LNK/ACT LED	Link activity LED.
	Speed LED	<ul style="list-style-type: none"> ■ Gigabit Ethernet: ■ Green: 1000M ■ Amber: 100M ■ Off: 10M
	System LED panel	See "System LED Panel" on page 5 for further details.

System LED Panel

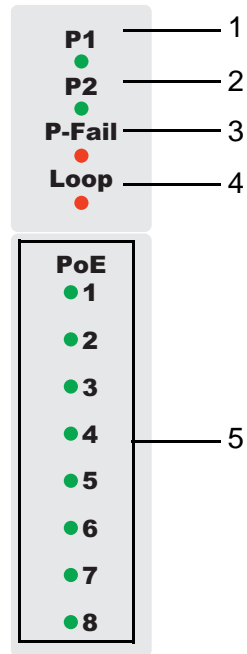

Figure 1.3 System LED Panel

No.	LED Name	LED Color	Description
	PW1 LED	Solid green	Powered up.
		Off	Powered down or not installed.
	PW2 LED	Solid green	Powered up.
		Off	Powered down or not installed.
	P-Fail	Solid red	When PW1 or PW2 is disconnected, the LED lights.
		Off	When PW1 and PW2 is connected, the LED is off.
	Loop	Solid red	When loop detected, the LED lights.
		Off	No loop detected.
	PoE (depending the PoE ports)	Solid green	PoE activated.
		Off	PoE non-working.

1.2.2 Rear View

The following view applies to EKI-5624PI and EKI-5729PI.

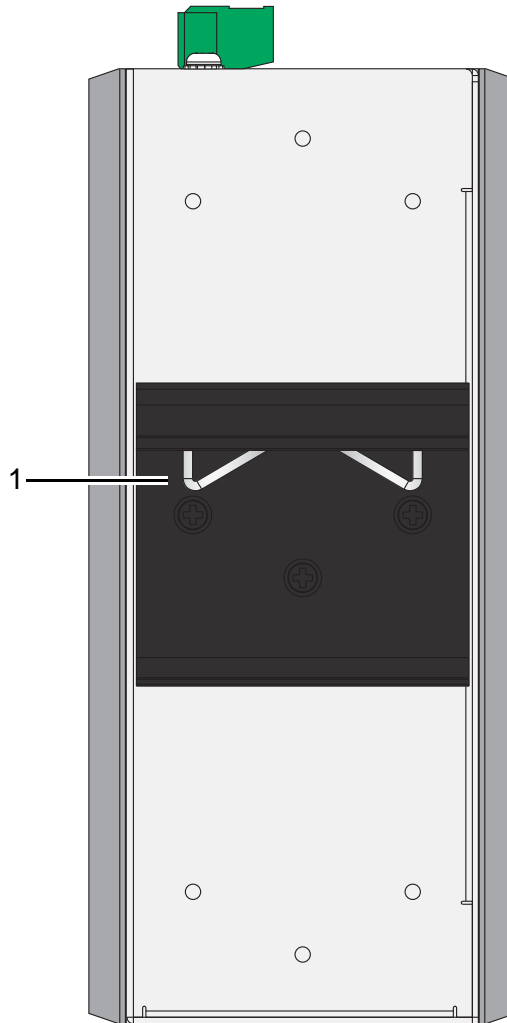

Figure 1.4 Rear View

No.	Item	Description
	DIN-Rail mounting plate	Mounting plate used for the installation to a standard DIN rail.

1.2.3 Top View

The following view applies to EKI-5624PI and EKI-5729PI.

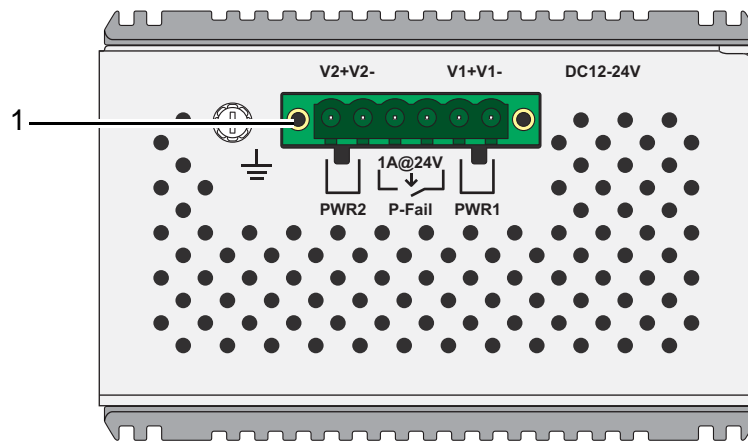

Figure 1.5 Top View

No.	Item	Description
	Terminal block	Connect cabling for power and alarm wiring.

1.2.4 Bottom View

The following view applies to EKI-5624PI and EKI-5729PI.

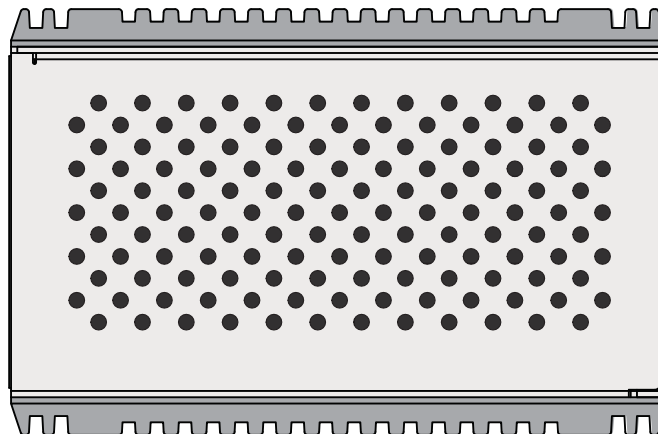

Figure 1.6 Bottom View

Chapter 2

Switch Installation

2.1 Installation Guidelines

The following guidelines are provided to optimize the device performance. Review the guidelines before installing the device.

- Make sure cabling is away from sources of electrical noise. Radios, power lines, and fluorescent lighting fixtures can interfere with the device performance.
- Make sure the cabling is positioned away from equipment that can damage the cables.
- Operating environment is within the ranges listed range, see “Specifications” on page 1.
- Relative humidity around the switch does not exceed 95 percent (noncondensing).
- Altitude at the installation site is not higher than 10,000 feet.
- In 10/100 and 10/100/1000 fixed port devices, the cable length from the switch to connected devices can not exceed 100 meters (328 feet).
- Make sure airflow around the switch and respective vents is unrestricted. Without proper airflow the switch can overheat. To prevent performance degradation and damage to the switch, make sure there is clearance at the top and bottom and around the exhaust vents.

2.1.1 Connecting Hardware

In this instruction, it will explain how to find a proper location for your Modbus Gateways, and how to connect to the network, hook up the power cable, and connect to the EKI-5729PI & EKI-5624PI.

2.2 Verifying Switch Operation

Before installing the device in a rack or on a wall, power on the switch to verify that the switch passes the power-on self-test (POST). To connect the cabling to the power source see “Power Supply Installation” on page 16.

At startup (POST), the System LED blinks green, while the remaining LEDs are a solid green. Once the switch passes POST self-test, the System LED turns green. The other LEDs turn off and return to their operating status. If the switch fails POST, the System LED switches to an amber state.

After a successful self-test, power down the switch and disconnect the power cabling. The switch is now ready for installation on its final location.

2.3 Installing the Switch

2.3.1 DIN Rail Mounting

The DIN rail mount option is the quickest installation option. Additionally, it optimizes the use of rail space.

The metal DIN rail kit is secured to the rear of the switch. The device can be mounted onto a standard 35mm (1.37") x 75 mm (3") height DIN rail. The devices can be mounted vertically or horizontally. Refer to the following guidelines for further information.

Note! A corrosion-free mounting rail is advisable.



When installing, make sure to allow for enough space to properly install the cabling.

Installing the DIN-Rail Mounting Kit

1. Insert the top back of the mounting bracket over the DIN rail.
2. Push the bottom of the switch towards the DIN rail until it snaps into place.

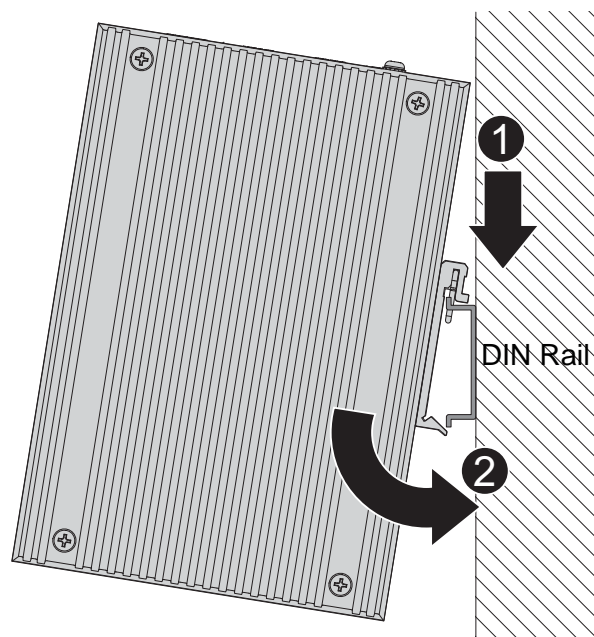

Figure 2.1 Installing the DIN-Rail Mounting Kit

Removing the DIN-Rail Mounting Kit

1. Push the switch down to free the bottom of the plate from the DIN rail.
2. Rotate the bottom of the device towards you and away from the DIN rail.

3. Once the bottom is clear of the DIN rail, lift the device straight up to unhook it from the DIN rail.

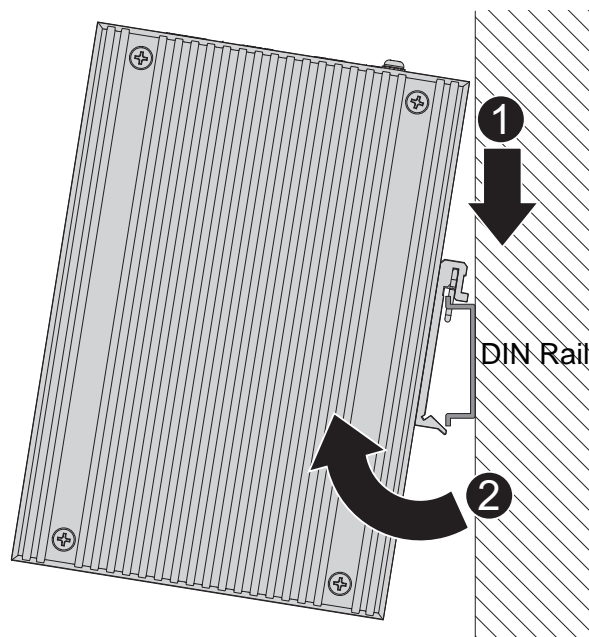

Figure 2.2 Removing the DIN-Rail

2.3.2 Wall-Mounting

The wall mounting option provides better shock and vibration resistance than the DIN rail vertical mount.

Note! *When installing, make sure to allow for enough space to properly install the cabling.*



Before the device can be mounted on a wall, you will need to remove the DIN rail plate.

1. Rotate the device to the rear side and locate the DIN mounting plate.
2. Remove the screws securing the DIN mounting plate to the rear panel of the switch.
3. Remove the DIN mounting plate. Store the DIN mounting plate and provided screws for later use.
4. Align the wall mounting plates on the rear side. The screw holes on the device and the mounting plates must be aligned, see the following illustration.

- Secure the wall mount plates with M3 screws, see the following figure.

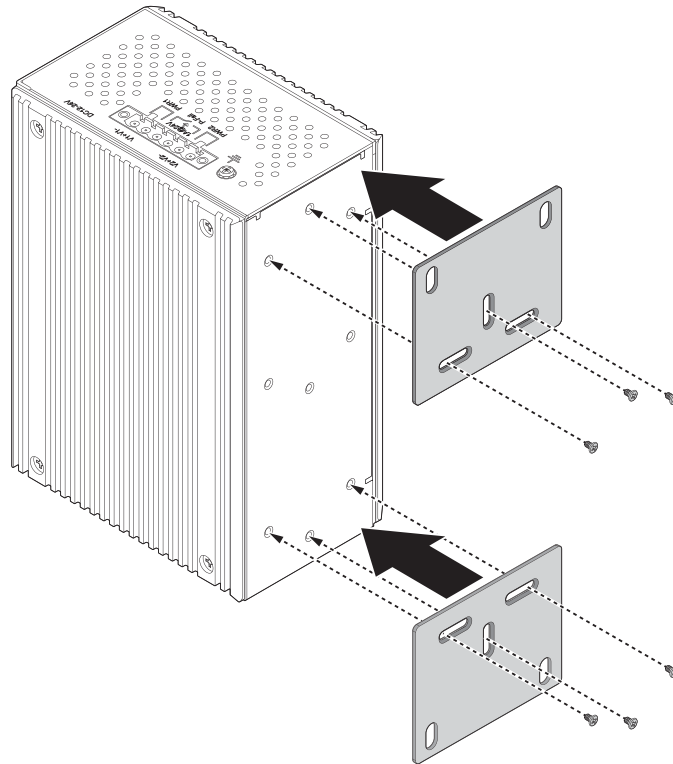

Figure 2.3 Installing Wall Mount Plates

Once the wall mounting plates are secure on the device, you will need to attach the wall screws (x6).

- Locate the installation site and place the switch against the wall, making sure it is the final installation location.
- Use the wall mount plates as a guide to mark the locations of the screw holes.
- Drill four holes over the four marked locations on the wall, keeping in mind that the holes must accommodate wall sinks in addition to the screws.
- Insert the wall sinks into the walls.
- Insert the screws into the wall sinks. Leave a 2 mm gap between the wall and the screw head to allow for wall mount plate insertion.



Figure 2.4 Securing Wall Mounting Screws

- Note!**
- Make sure the screws dimensions are suitable for use with the wall mounting plate.
 - Do not completely tighten the screws into the wall. A final adjustment may be needed before fully securing the wall mounting plates on the wall.

11. Align the wall mount plate over the screws on the wall.
12. Install the wall mount plate on the screws and slide it forward to lock in place, see the following figure.

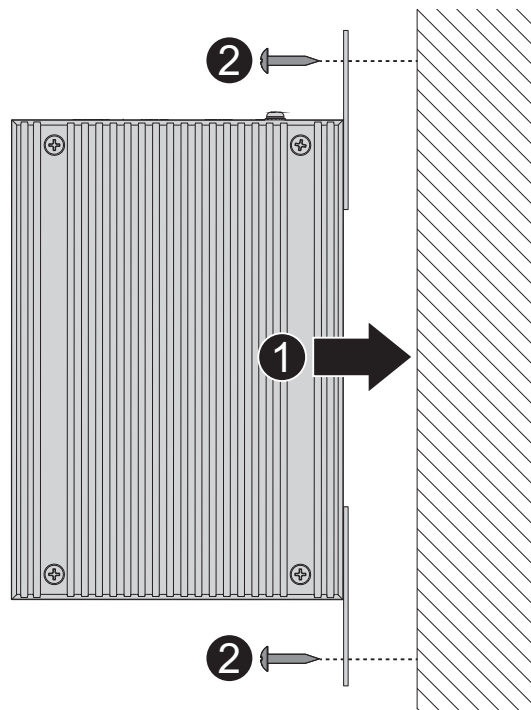

Figure 2.5 Wall Mount Installation

13. Once the device is installed on the wall, tighten the screws to secure the device.

2.4 Connecting the Switch to Ethernet Ports

2.4.1 RJ45 Ethernet Cable Wiring

For RJ45 connectors, data-quality, twisted pair cabling (rated CAT5 or better) is recommended. The connector bodies on the RJ45 Ethernet ports are metallic and connected to the GND terminal. For best performance, use shielded cabling. Shielded cabling may be used to provide further protection.

Straight-thru Cable Wiring		Cross-over Cable Wiring	
Pin 1	Pin 1	Pin 1	Pin 3
Pin 2	Pin 2	Pin 2	Pin 6
Pin 3	Pin 3	Pin 3	Pin 1
Pin 6	Pin 6	Pin 6	Pin 2

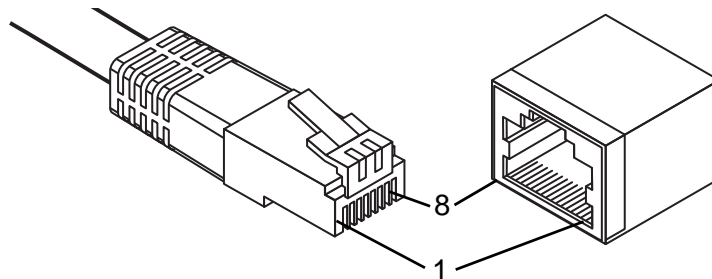

Figure 2.6 Ethernet Plug & Connector Pin Position

Maximum cable length: 100 meters (328 ft.) for 10/100/1000BaseT.

2.5 Power Supply Installation

2.5.1 Overview

Warning! Power down and disconnect the power cord before servicing or wiring the switch.



Caution! Do not disconnect modules or cabling unless the power is first switched off.



The device only supports the voltage outlined in the type plate. Do not use any other power components except those specifically designated for the switch device.

Caution! Disconnect the power cord before installation or cable wiring.



The switches can be powered by using the same DC source used to power other devices. A DC voltage range of 12 to 24VDC must be applied between the V1+ terminal and the V1- terminal (PW1), see the following illustrations. A Class 2 power supply is required to maintain a UL60950 panel listing. The chassis ground screw terminal should be tied to the panel or chassis ground. A redundant power configuration is supported through a secondary power supply unit to reduce network down time as a result of power loss.

EKI-5729PI & EKI-5624PI support 12 to 24 VDC. Dual power inputs are supported and allow you to connect a backup power source.

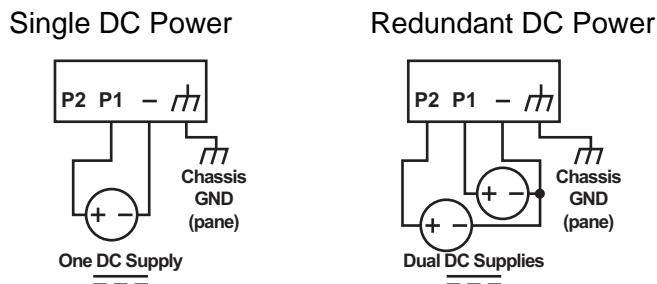

Figure 2.7 Power Wiring for EKI-5729PI & EKI-5624PI

2.5.2 Considerations

Take into consideration the following guidelines before wiring the device:

- The Terminal Block (CN1) is suitable for 12-24 AWG (3.31 - 0.205 mm²). Torque value 7 lb-in.
- The cross sectional area of the earthing conductors shall be at least 3.31 mm².
- Calculate the maximum possible current for each power and common wire. Make sure the power draw is within limits of local electrical code regulations.
- For best practices, route wiring for power and devices on separate paths.
- Do not bundle together wiring with similar electrical characteristics.

- Make sure to separate input and output wiring.
- Label all wiring and cabling to the various devices for more effective management and servicing.

Note! *Routing communications and power wiring through the same conduit may cause signal interference. To avoid interference and signal degradation, route power and communications wires through separate conduits.*



2.5.3 Grounding the Device

Caution! *Do not disconnect modules or cabling unless the power is first switched off.*



The device only supports the voltage outlined in the type plate. Do not use any other power components except those specifically designated for the switch device.

Caution! *Before connecting the device properly ground the device. Lack of a proper grounding setup may result in a safety risk and could be hazardous.*



Caution! *Do not service equipment or cables during periods of lightning activity.*



Caution! *Do not block air ventilation holes.*



Electromagnetic Interference (EMI) affects the transmission performance of a device. By properly grounding the device to earth ground through a drain wire, you can setup the best possible noise immunity and emissions.

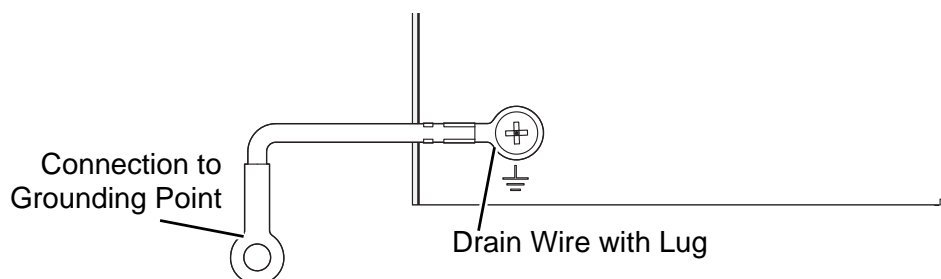

Figure 2.8 Grounding Connection

By connecting the ground terminal by drain wire to earth ground the switch and chassis can be ground.

Note! Before applying power to the grounded switch, it is advisable to use a volt meter to ensure there is no voltage difference between the power supply's negative output terminal and the grounding point on the switch.



2.5.4 Wiring a Relay Contact

The following section details the wiring of the relay output. The terminal block on the EKI-5729PI & EKI-5624PI is wired and then installed onto the terminal receptor located on the EKI-5729PI & EKI-5624PI.

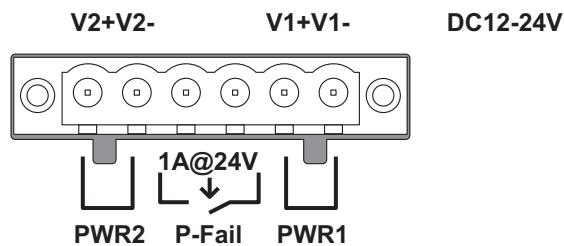

Figure 2.9 Terminal Receptor: Relay Contact for PoE models

The terminal receptor includes a total of six pins: two for PWR1, two for PWR2 and two for a fault circuit.

2.5.5 Wiring the Power Inputs

Warning! Power down and disconnect the power cord before servicing or wiring the switch.



Caution! Do not disconnect modules or cabling unless the power is first switched off.



The device only supports the voltage outlined in the type plate. Do not use any other power components except those specifically designated for the switch device.

There are two power inputs for normal and redundant power configurations. The power input 2 is used for wiring a redundant power configuration. See the following for terminal block connector views.

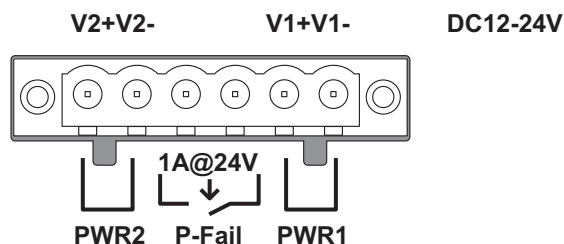

Figure 2.10 Terminal Receptor: Power Input Contacts for PoE models

To wire the power inputs:

Make sure the power is not connected to the switch or the power converter before proceeding.

1. Loosen the screws securing terminal block to the terminal block receptor.
2. Remove the terminal block from the switch.

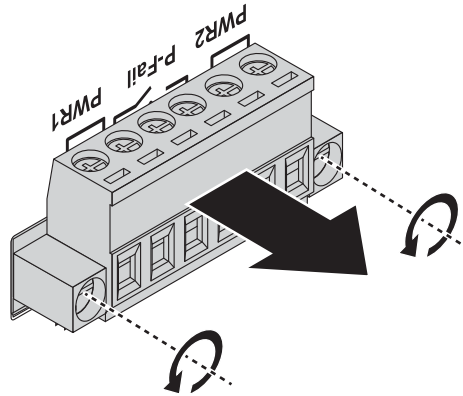

Figure 2.11 Removing a Terminal Block

3. Insert a small flat-bladed screwdriver in the V1+/V1- wire-clamp screws, and loosen the screws.
4. Insert the negative/positive DC wires into the V+/V- terminals of PW1. If setting up power redundancy, connect PW2 in the same manner.
5. Tighten the wire-clamp screws to secure the DC wires in place.

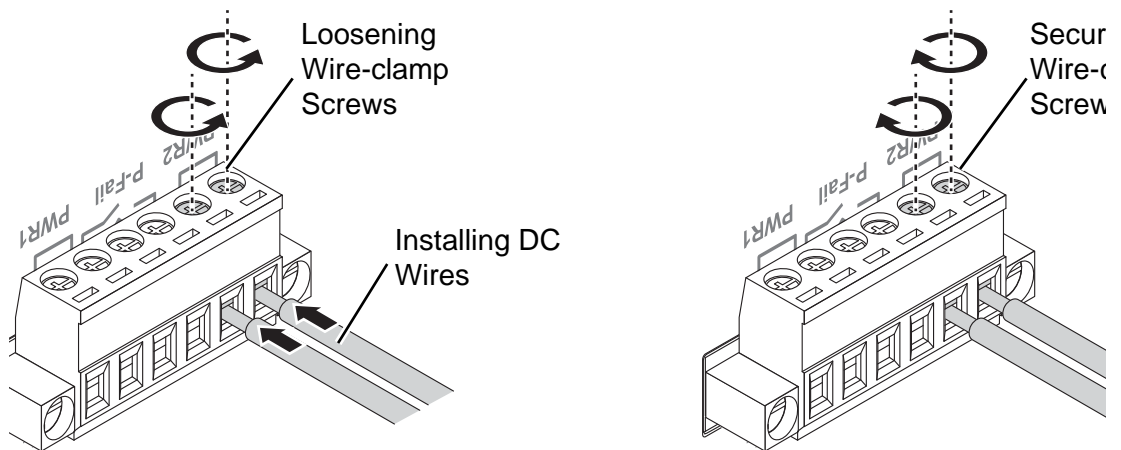

Figure 2.12 Installing DC Wires in a Terminal Block

6. Align the terminal block over the terminal block receptor on the switch.
7. Insert the terminal block and press it in until it is flush with the terminal block receptor.
8. Tighten the screws on the terminal block to secure it to the terminal block receptor.

If there is no gap between the terminal block and the terminal receptor, the terminal block is seated correctly.

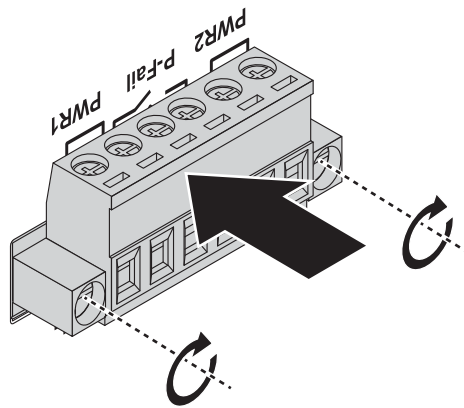

Figure 2.13 Securing a Terminal Block to a Receptor

Chapter 3

Configuration Utility

3.1 Overview

This section describes the installation procedures for the Advantech EKI Device Configuration Utility.

The Configuration Utility is the software tool for setting up and monitoring the EKI-5729PI & EKI-5624PI.

3.2 Enabling ProView Function

The configuration of a ProView switch can be accessed by using EKI Device Configuration Utility. To install the software utility see “Installing the Configuration Utility” on page 23.

The ProView features for the device must be enabled. The following guidelines allow you to enable and disable the ProView features.

Note! *Microsoft Windows 7 is used as a reference for the development of the following guidelines. The following navigation references may differ depending on your operating system.*



To fully access all the available options in the Configuration Utility, administrative privileges are required. Without the use of administrative privileges, some functions of the Configuration Utility are not accessible.

Before continuing further, any devices selected for configuration must be connected and powered on, see “Installation Guidelines” on page 9.

1. From your Windows desktop, locate the **Start** button to open the Start Menu.
2. Navigate to **All Programs > EKI Device Configuration Utility**.
3. Locate **Advantech EKI Device Configuration Utility** and right-click on it. From the pop-up menu, select **Run as Administrator**. See your network administrator to obtain the privileges required.
4. A security screen displays, select **Yes** to continue.
5. Select **Search Again** to detect any connected devices.
Once a device is detected, it is listed under the **EKI Device** listing in the **Tree View**.
6. Select the device to configure by clicking on it.
7. Select **System** tab to bring up the **Enable ProView Features** field.
Before a device can be configured, the ProView feature must be enabled.

- Click the Enable ProView Features radio button and click **Apply** to configure the device.

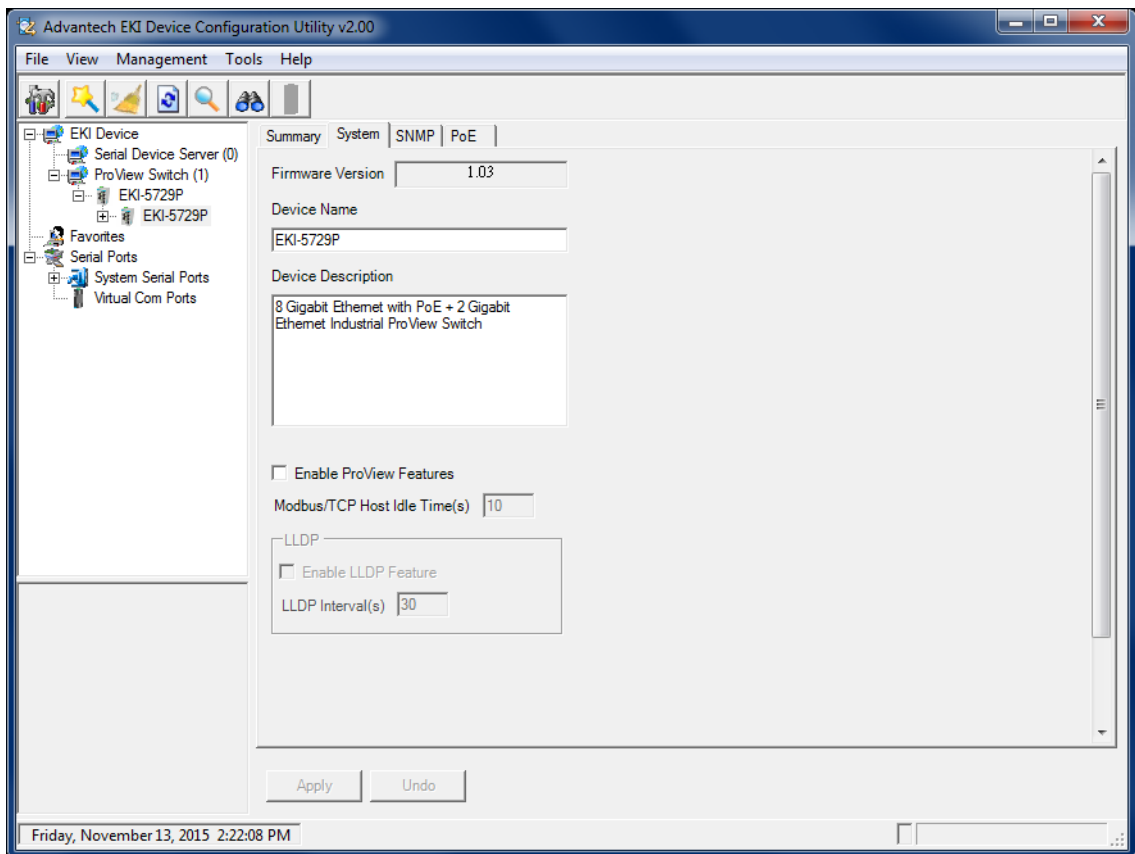

Figure 3.1 Enabling ProView Features

The ProView function is enabled and the switch can be configured.

3.3 Installing the Configuration Utility

Note! Microsoft .NET Framework version 2.0 or greater is required for this application.



- Insert the Advantech EKI Device Configuration Utility CD-ROM into the CD-ROM drive (whereas E:\ is the drive name of your CD-ROM) on the host PC.
- Use Windows explorer or the Windows Run command to execute the setup program, the path for the setup program on the CD-ROM is as follows:
E:\EKI_Device_Configuration_Utility_v2.01.exe
- If there is an existing COM port mapping utility on the host PC, remove it at this time. A system reboot may be necessary before continuing the installation.

- Once the InstallShield Wizard screen displays, click **Next** to proceed with the installation.

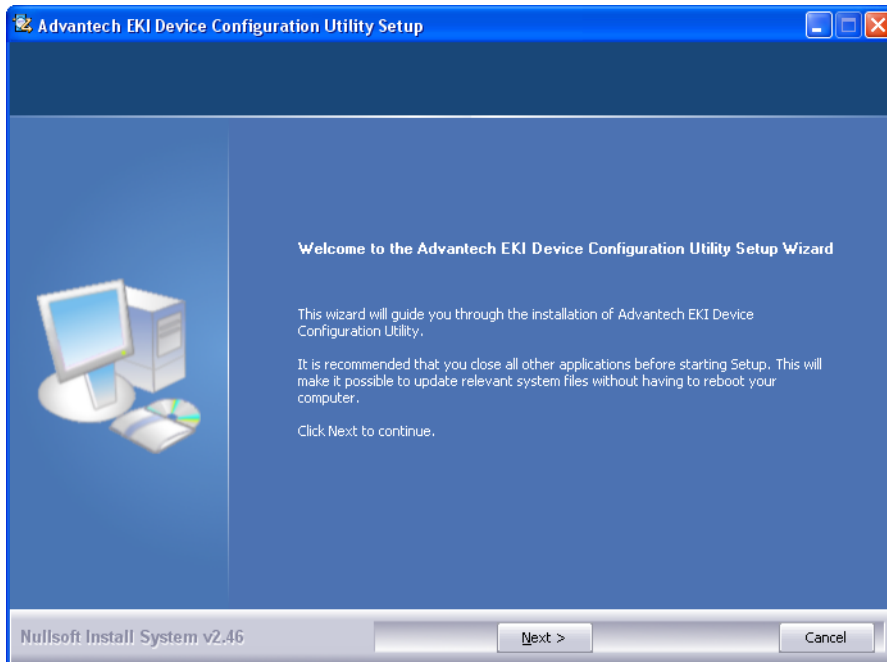

Figure 3.2 InstallShield Wizard 1 of 4

- The Software License Agreement displays, press **I Agree** to continue or **Cancel** to stop the installation.

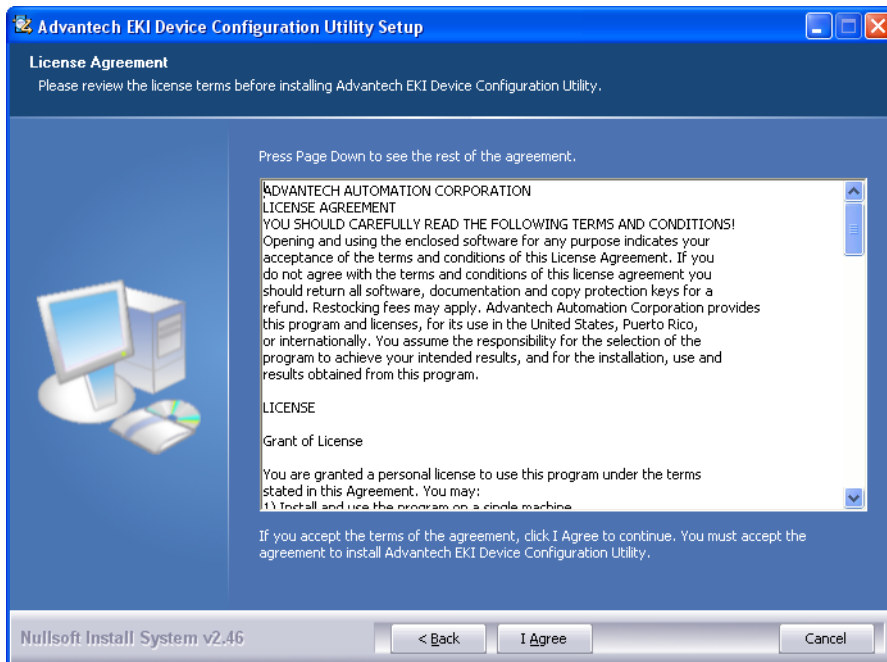

Figure 3.3 InstallShield Wizard 2 of 4

The InstallShield continues and a status screen displays. The default installation path is C:\Program Files\EKI Device Configuration Utility.

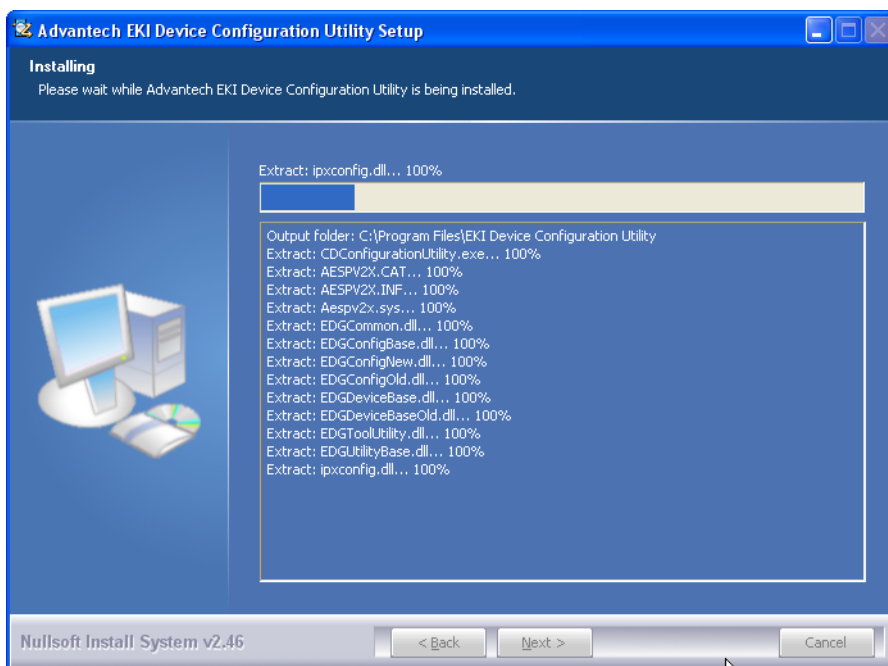

Figure 3.4 InstallShield Wizard 3 of 4

6. Once the installation of the package is finished a Configuration Utility Setup screen displays. Click **Finish** to conclude the process and exit the InstallShield Wizard.

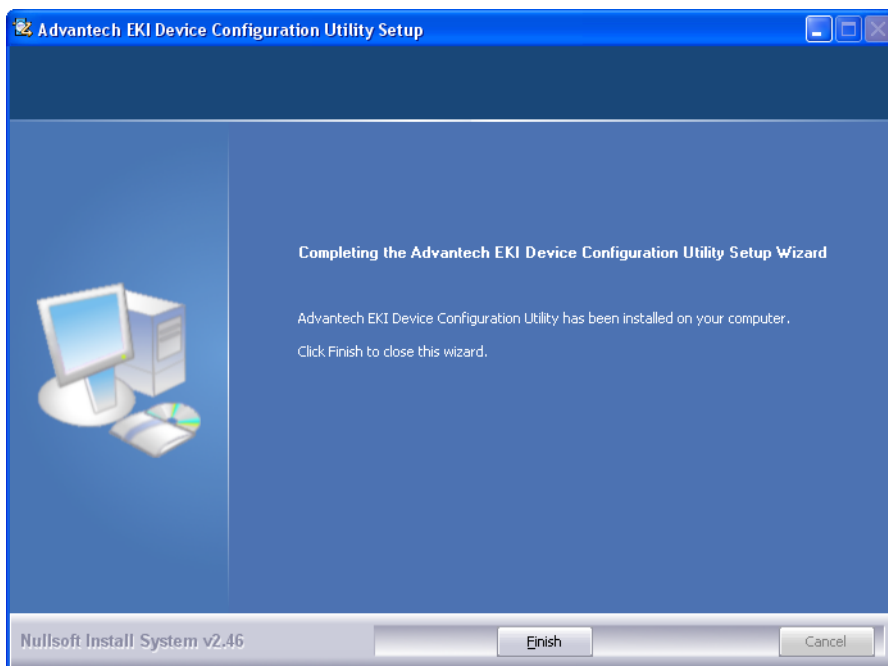

Figure 3.5 InstallShield Wizard 4 of 4

3.4 Utility Menu Map

The EKI Configuration Utility can be installed on different operating systems, however, Windows 7 is the recommended version.

Click **Start > All Programs > EKI Device Configuration Utility > Advantech EKI Device Configuration Utility**. The EKI Device Configuration Utility screen appears, see the following figure.

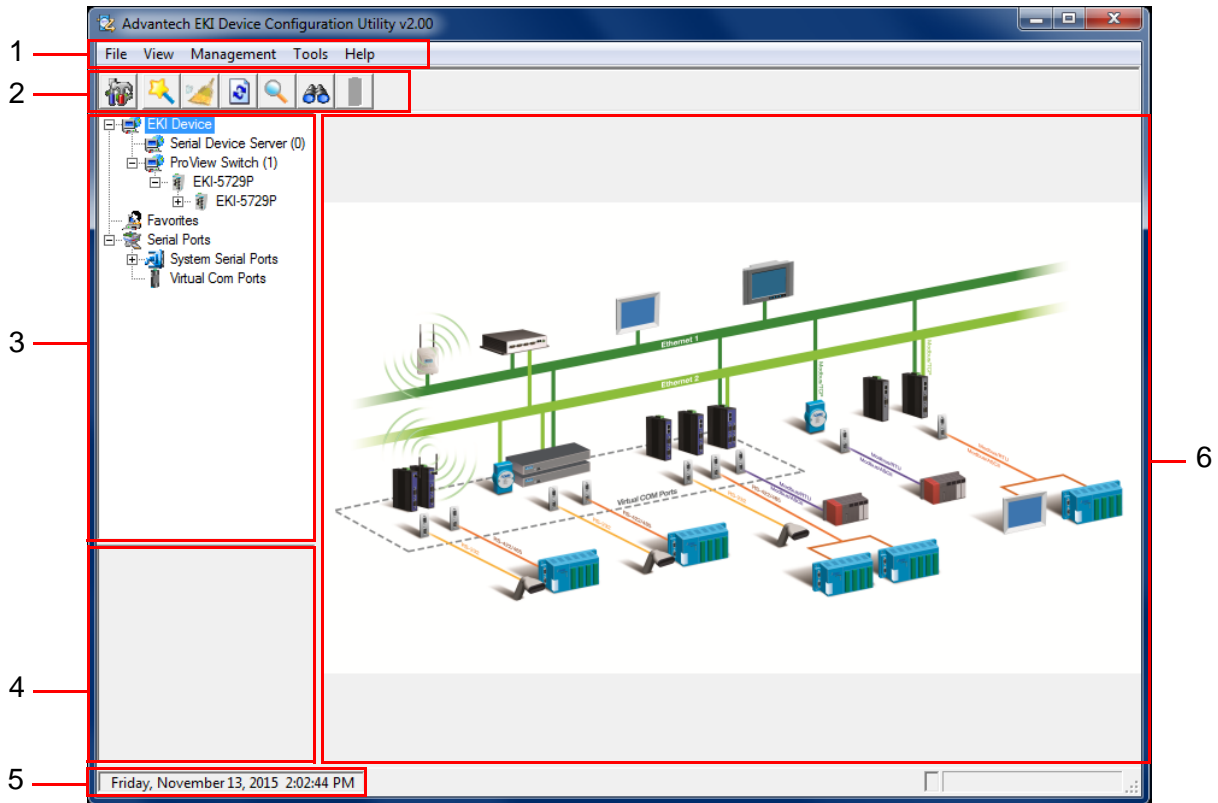

Figure 3.6 Configuration Utility Overview

No	Item	Description
1	Menu Bar	Displays File, View, Management, Tools and Help.
2	Tool Bar	Useful management functions' shortcuts.
3	Tree View	All devices will be searched and listed in this area. You can arrange different favorite group and virtual COM ports.
4	Information Panel	Click on the devices or move cursor to the devices, the related information is shown in this area.
5	Status Bar	Displays the current time.
6	Configuration Area	Click on the items on the TreeView Area, the configuration page displays in this area.

3.5 Menu Bar

3.5.1 View Menu

3.5.1.1 Utility Settings

Click **View > Settings** to configure utility settings.

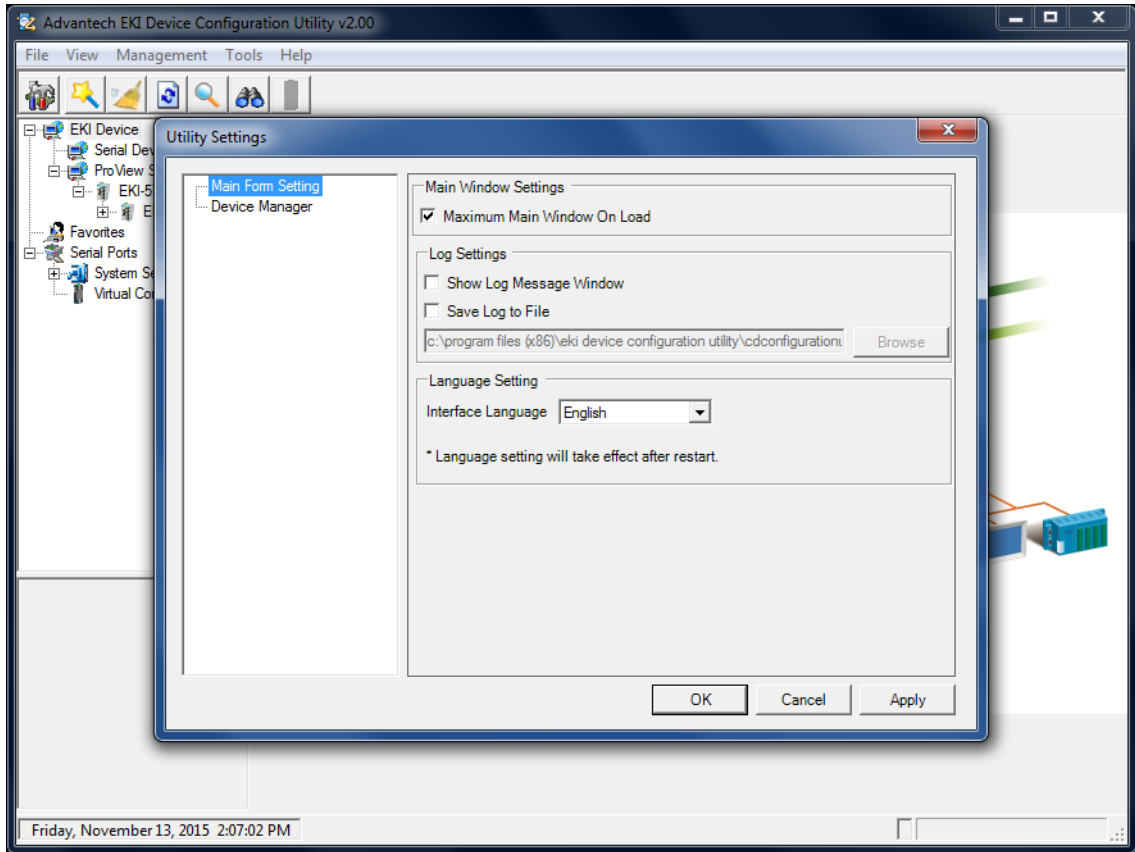

Figure 3.7 View > Settings > Main Form Setting

Item	Description
Main Window Settings	
Maximum Main Window On Load	Check the box to enable the limiting of main windows on-load to the maximum value.
Log Settings	
Show Log Message Window	Check the checkbox to show the log message.
Save Log to File	Check the checkbox to save log to file.
Browse	Click Browse to choose a file to save.
Language Settings	
Interface Language	Click the drop-down menu to select an interface language: Traditional Chinese, Simplified Chinese or English.
OK	Click OK to save and exit the utility setting.
Cancel	Click Cancel to discard the changes.
Apply	Click Apply to save the utility setting.

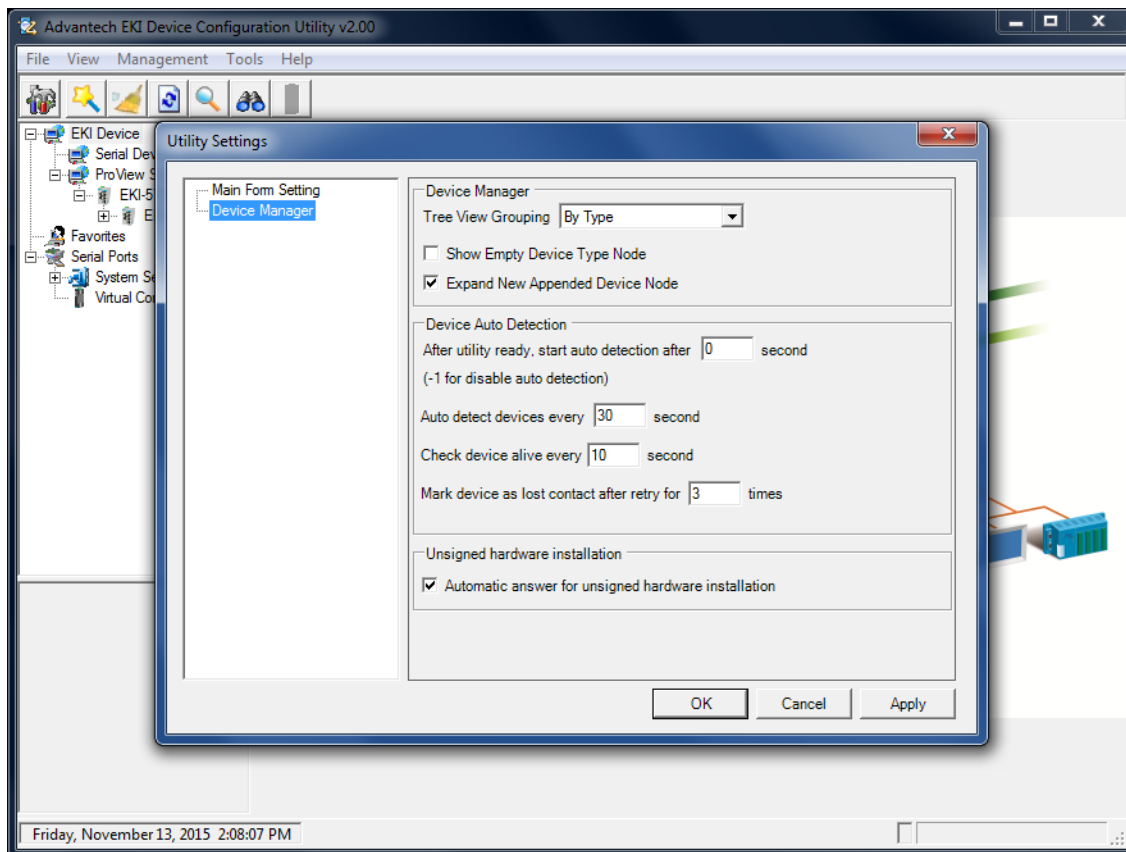

Figure 3.8 View > Settings > Device Manager

Item	Description
Device Manager	
Tree View Grouping	Click the drop-down menu to enable or disable grouping.
Show Empty Device Type Node	Check the checkbox to show empty device type node or not.
Expand New Appended Device Node	Check the checkbox to expand a new appended device node or not.
Device Auto Detection	
After utility ready, start auto detection after X second	Enter a value to specify the time to auto detection time (-1 means disable auto detection).
Auto detect devices every X second	Enter a value to specify the time to auto detect devices.
Check device alive every X second	Enter a value to specify the time to check device alive.
Mark device as lost contact after retry for X times	Enter a value to specify the time to mark device as lost contact.
Unsigned Hardware Installation	
Automatic answer for unsigned hardware installation	Check the checkbox to enable or disable answer automatically for unsigned hardware installation.
OK	Click OK to save and exit the utility setting.
Cancel	Click Cancel to discard the changes.
Apply	Click Apply to save the utility setting.

3.5.2 Management Menu







Item	Description
Configuration Wizard	Start the software wizard (setup assistant) to leads you through the VCOM configuration process for device server product.
Clear Device List and Search Again	Clear all device list and re-search devices.
Search Again	Re-search devices.
Add IP Address to Favorite	Add one device to Favorites.
Search for a Range of IP Addresses	Add a group of device to Favorites.
Manual Direct Mapping Virtual COM Port	Click to add a target by selecting a Device Type and inputting the IP address, physically connecting the serial device server to the network is not required.

3.5.3 Help Menu

Item	Description
Check Utility Update	Select to update configuration utility.
About	Select to show the information about the configuration utility.

3.6 Tool Bar

The tool bar is a list of shortcuts for the most frequently used menu functions. Icons are provided for each function. By clicking on the icon, the most frequently used functions can be accessed.

Icon	Item	Description
	Utility Settings	Refer to "Utility Settings" on page 27.
	Configuration Wizard	Refer to "Management Menu" on page 29.
	Clear Device List and Search Again	Refer to "Management Menu" on page 29.
	Auto Search (Search Again)	Refer to "Management Menu" on page 29.
	Add IP Address to Favorite	Refer to "Management Menu" on page 29.
	Search for a Range of IP Addresses	Refer to "Management Menu" on page 29.
	Manual Direct Mapping Virtual COM Port	Refer to "Management Menu" on page 29.

3.7 TreeView

The TreeView configuration area displays the selected device's configurable settings. From this area you can directly group devices in the favorite's list. See "Utility Menu Map" on page 26.

3.8 Information Panel

The Information Panel area displays the selected device's related information. See "Utility Menu Map" on page 26.

3.9 Status Bar

The Status Bar area displays the current time. See "Utility Menu Map" on page 26.

3.10 Configuration Area

The Configuration Area displays correlating information from selected menu items within the TreeView area. See "Utility Menu Map" on page 26.

Chapter 4

Managing Switch

4.1 Discovering Switches

4.1.1 First Time Installation

Enabling ProView Function

See “Enabling ProView Function” on page 22 for further information.

Configuring Network Settings

EKI Device Configuration Utility provides two ways to configure network settings: DHCP + Auto IP Settings or Static Settings.

DHCP + Auto IP Settings

1. Select Ethernet under the desired device.
2. Click the drop-down menu to select **DHCP + Auto-IP**.
3. Click **Apply** to confirm the settings.

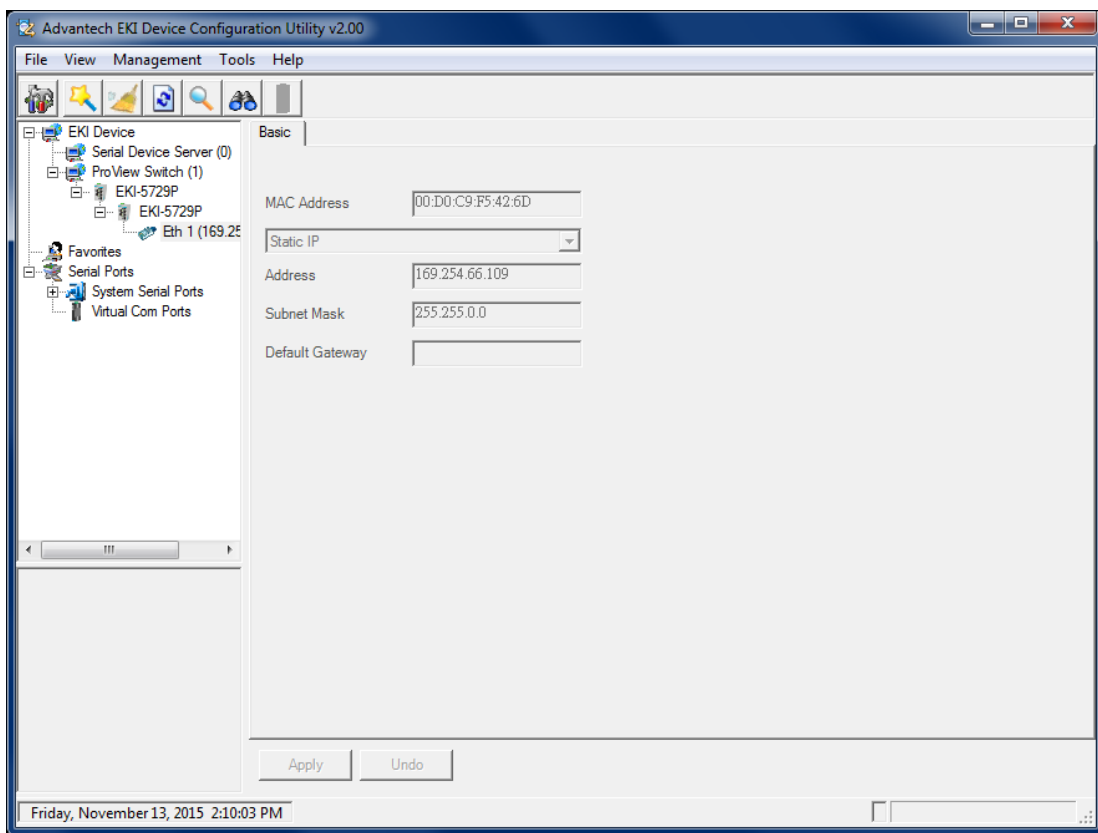

Figure 4.1 Selecting Networking Setting

Static Settings

1. Select Ethernet under the desired device.
2. Click the drop-down menu to select **Static IP**.
3. Enter the IP Address, Subnet Mask and Gateway.

4. Click **Apply** to confirm the settings.

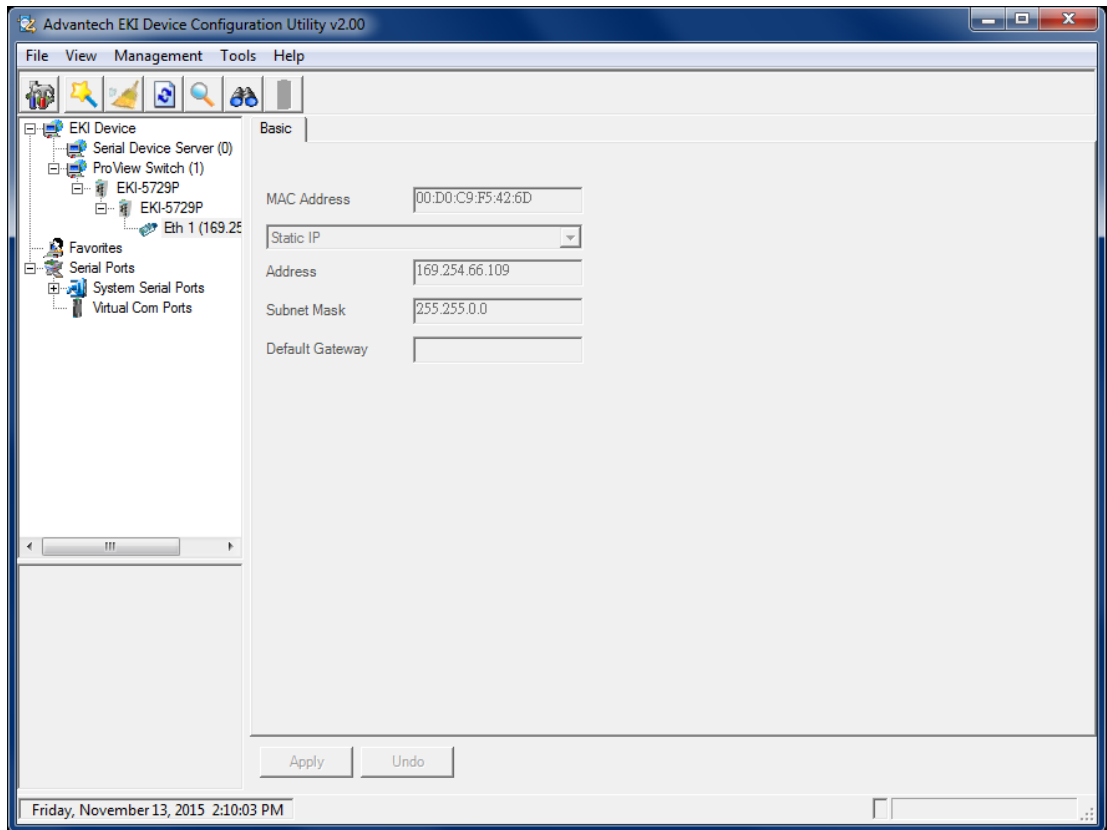

Figure 4.2 Configuring a Static IP Setting

4.1.2 Discovering Switches

Auto Search

Only devices within the same network domain can be listed through the search function. Once a device is listed, the features and configuration details are accessible by clicking on the device name.

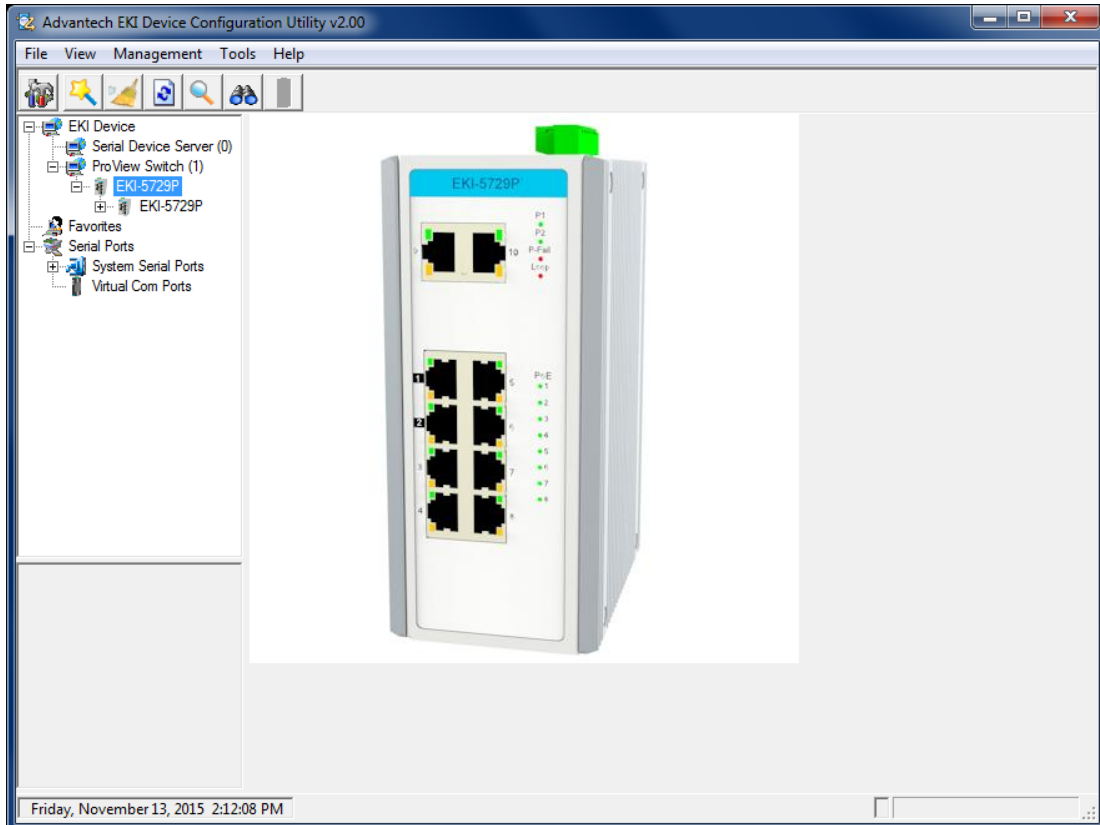



Figure 4.3 Auto Searching Screen

To search for a device:

1. From the Tool Bar, click the **Search Again**  button.

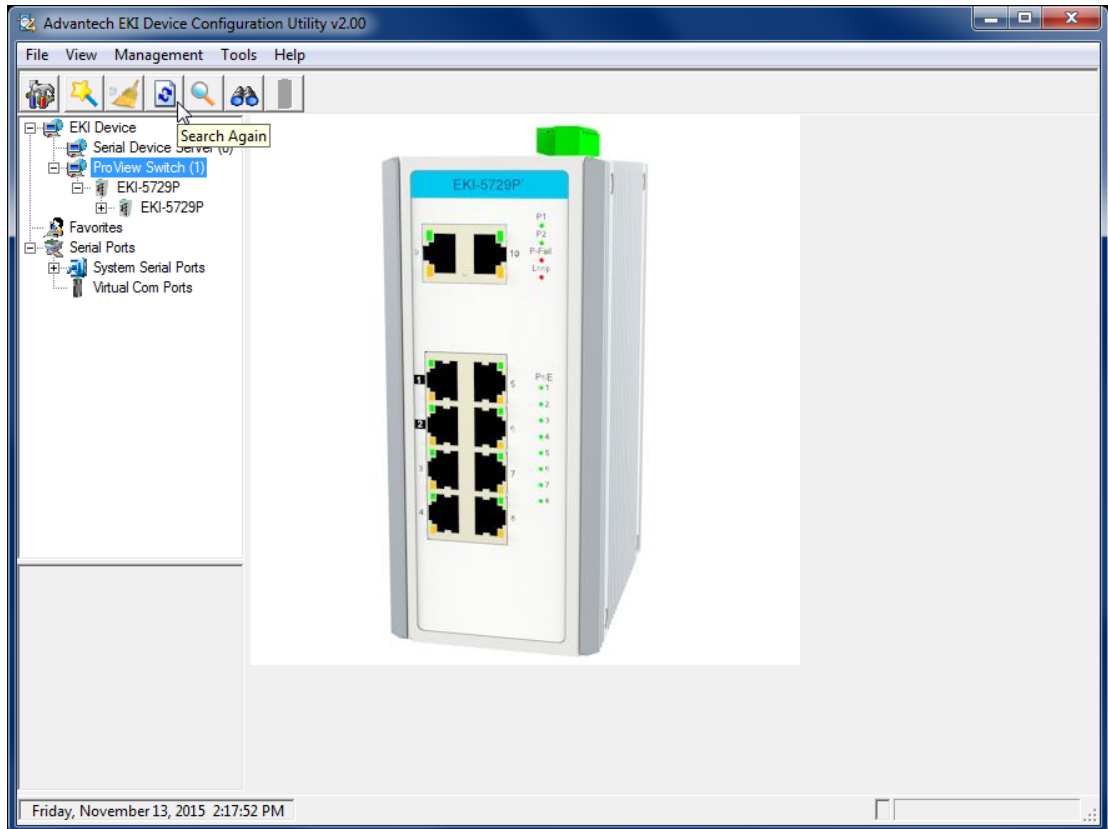



Figure 4.4 Selecting Search Again

Note! Access to the utility's full function list requires administrator privileges.



Clearing Device List and Search Again

The search list can be cleared for a new search request by clicking the **Clearing Device List and Search Again**  button. The function clears the listing of the devices. You can use the Search function again to detect any devices connected to the network domain.

4.1.3 Group Management

Creating Groups

Groups are best used to identify a set of devices with a common characteristic and to better organize the device pool.

To create a favorite group, please follow the instructions as follows:

1. Right-click Favorite to display the settings.
2. Select **Create Group** to enter group name.

3. Enter a group name and click **OK**.

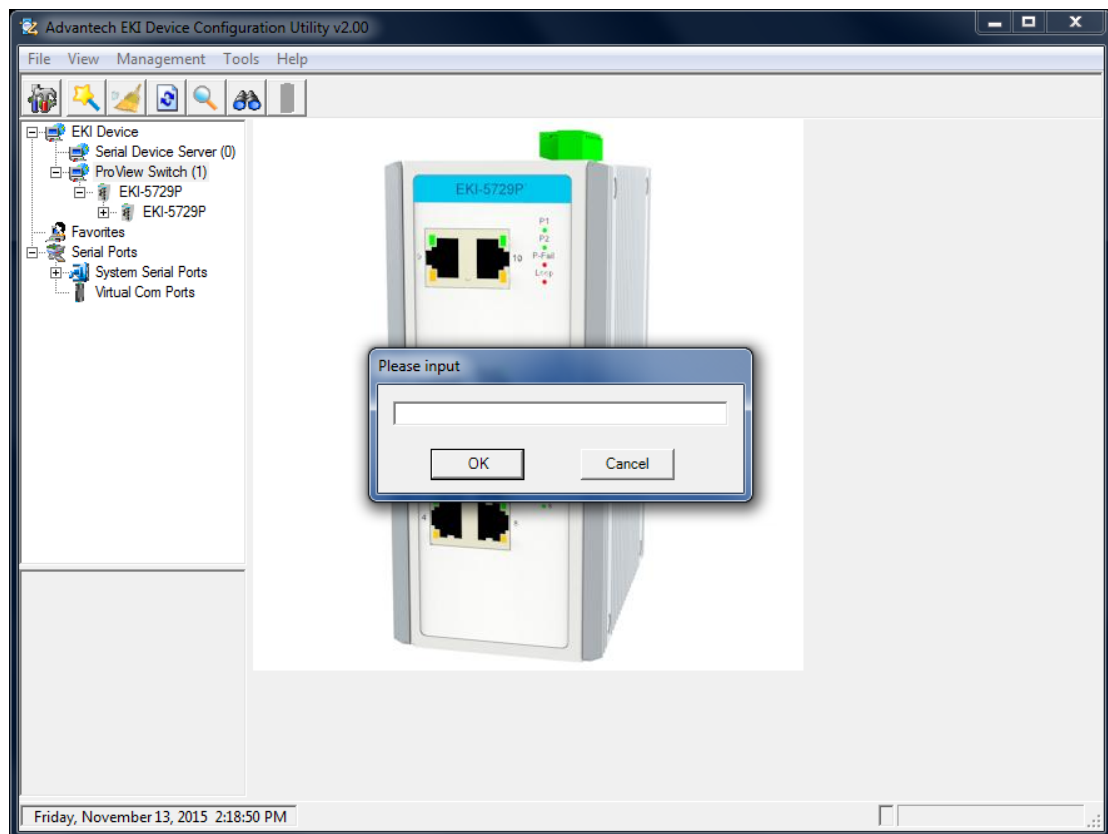

Figure 4.5 Adding a Group

The group is created and is available in the Favorite's List.

Favorite's List

A favorite's list is simple a way to organize the available devices by a category.

There are three ways to create a favorite's list: selecting a device, selecting an IP address, and selecting an IP address range. The following guidelines allow you to create a favorite's list.

Adding a Device

1. Right-click a desired device to display the settings menu.

2. Select **Add to Favorite**.

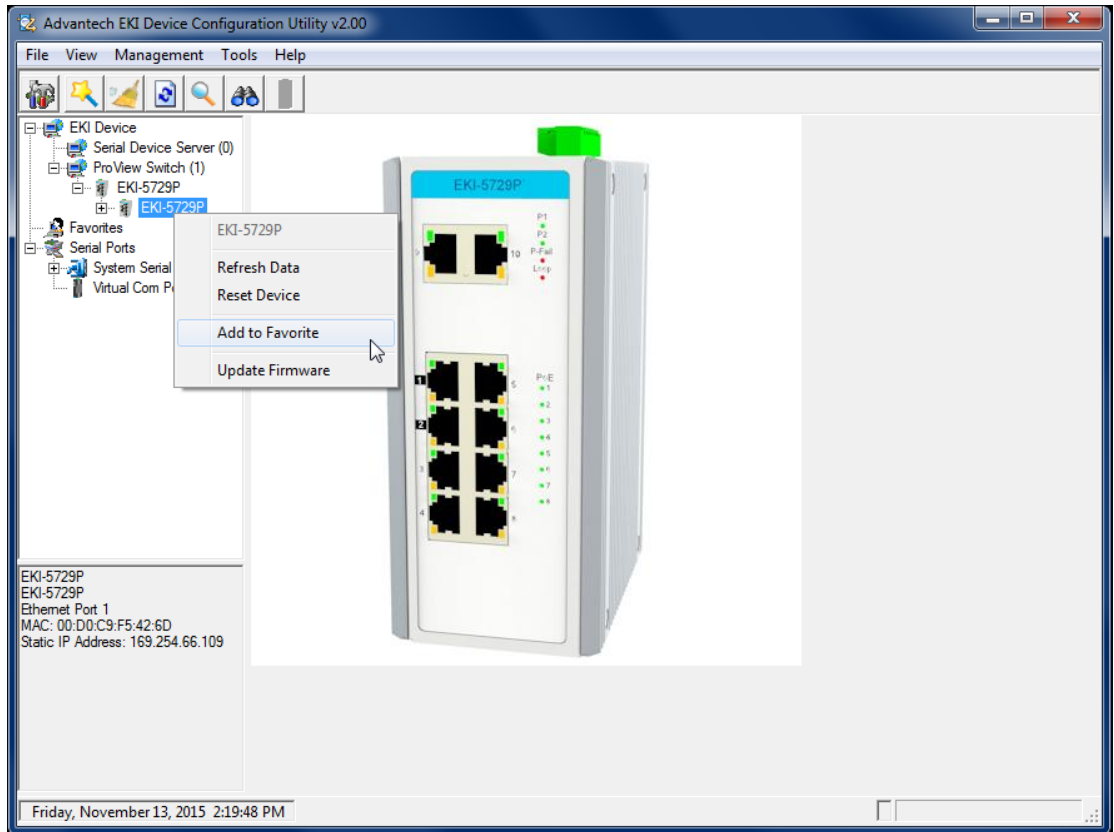

Figure 4.6 Adding a Switch to Favorites

In the event that there are existing groups, you can select the specific favorite group to include the selected device.

Adding an IP Address

1. From the Tool Bar, click the **Add IP Address to Favorite**  button.
2. Enter an IP address.

3. Click **OK** to add the IP address into the favorites list

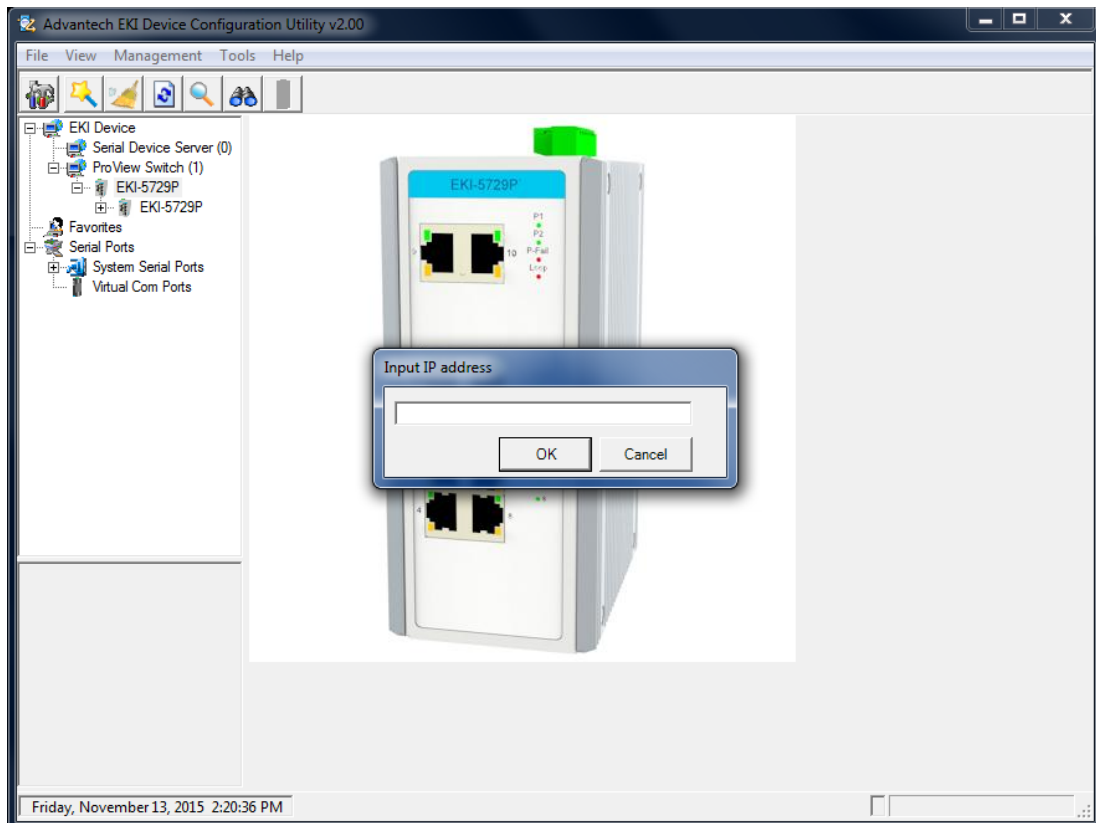



Figure 4.7 Add Favorite

In the event that there are existing groups, you can select the specific favorite group to include the selected IP address.

Adding an IP Address Range

1. From the Tool Bar, click the **Search for a Range of IP Addresses**  button.
2. Enter a starting and ending IP address range.

3. Click **OK** to add the range into the favorites list.

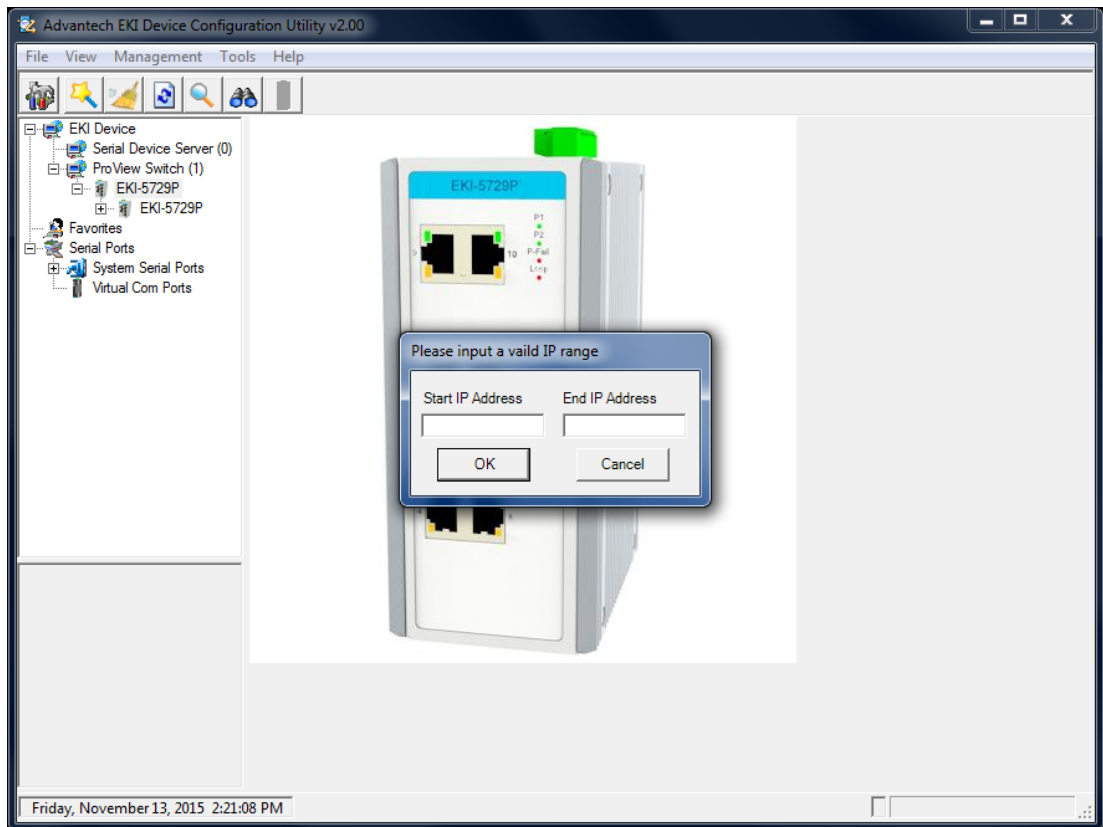

Figure 4.8 Add Favorite

In the event that there are existing groups, you can select the specific favorite group to include the selected IP address range.

4.1.4 Configuring the System

Changing Device Name

1. Select the device to configure by clicking on it.
2. In the Configuration Area, select **System** tab.
3. Locate the **Device Name** field, and enter a device name.

4. Click **Apply** to configure the device.

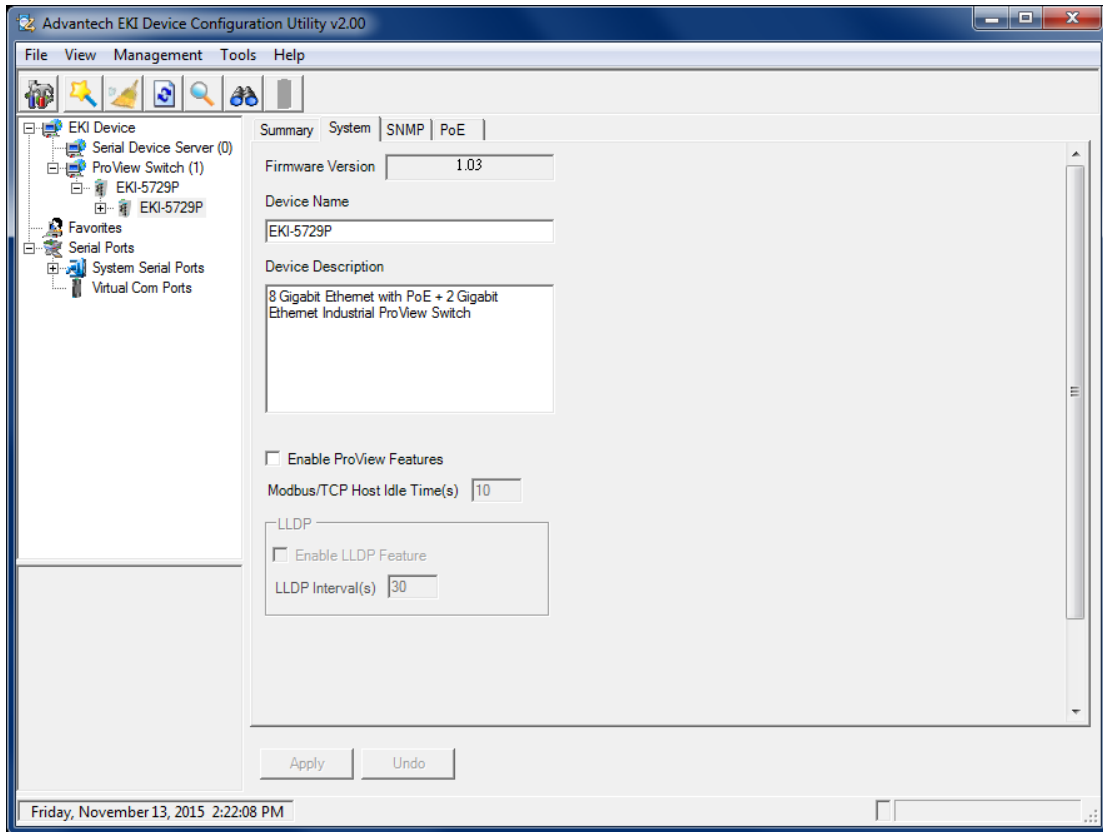

Figure 4.9 Changing Device Name

The device name is changed.

Setting Modbus/TCP Idle Time

1. Select the device to configure by clicking on it.
2. In the Configuration Area, select the **System** tab.
3. Locate the **Modbus/TCP Host Idle Time(s)** field.
4. Enter a variable representing the idle time for the Modbus/TCP host function.

ProView provides the following information to SCADA through Modbus/TCP.

- Vendor Name
- Production Name
- Firmware Version
- Ethernet MAC Address
- IP Address
- Port Status
- Port Speed
- Flow Control
- Port Description
- Link Up Counter
- PoE Status
- Tx Packets Counter
- Rx Packets Counter
- Tx Error Packets Counter
- Rx Error Packets Counter

5. Click **Apply** to configure the function.

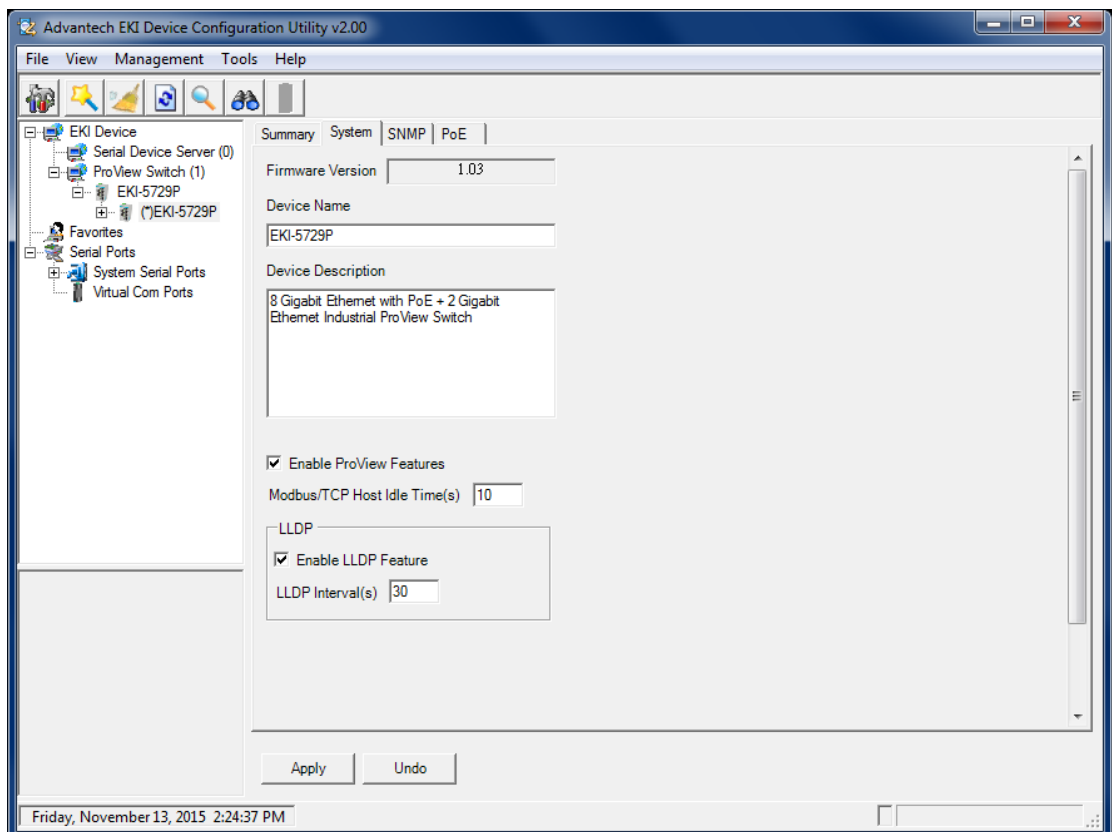

Figure 4.10 Setting Modbus/TCP Idle Time

The Modbus/TCP idle time is now set.

Setting LLDP

1. Select the device to configure by clicking on it.
2. In the Configuration Area, select the **System** tab.
3. Under LLDP, check **Enable LLDP Feature** to enable the LLDP feature. This feature is used by the device to advertise its identity, capabilities, and neighbors throughout the network.
4. Enter a variable representing the idle time for sending of LLDP information.

Setting Networks Parameters

For setting networks parameters, see “Configuring Network Settings” on page 32.

Setting SNMP

1. Select the device to configure by clicking on it.
2. In the Configuration Area, select **SNMP** tab.

The Basic and Community settings are listed for configuration.

3. In the SNMP Basic Settings selection, enter a contact and location in the respective fields.
4. In the SNMP Community Settings selection, the read-only and read-write strings are required.

5. In the SNMP Trap Setting selection, enter the IP address of the SNMP trap server.

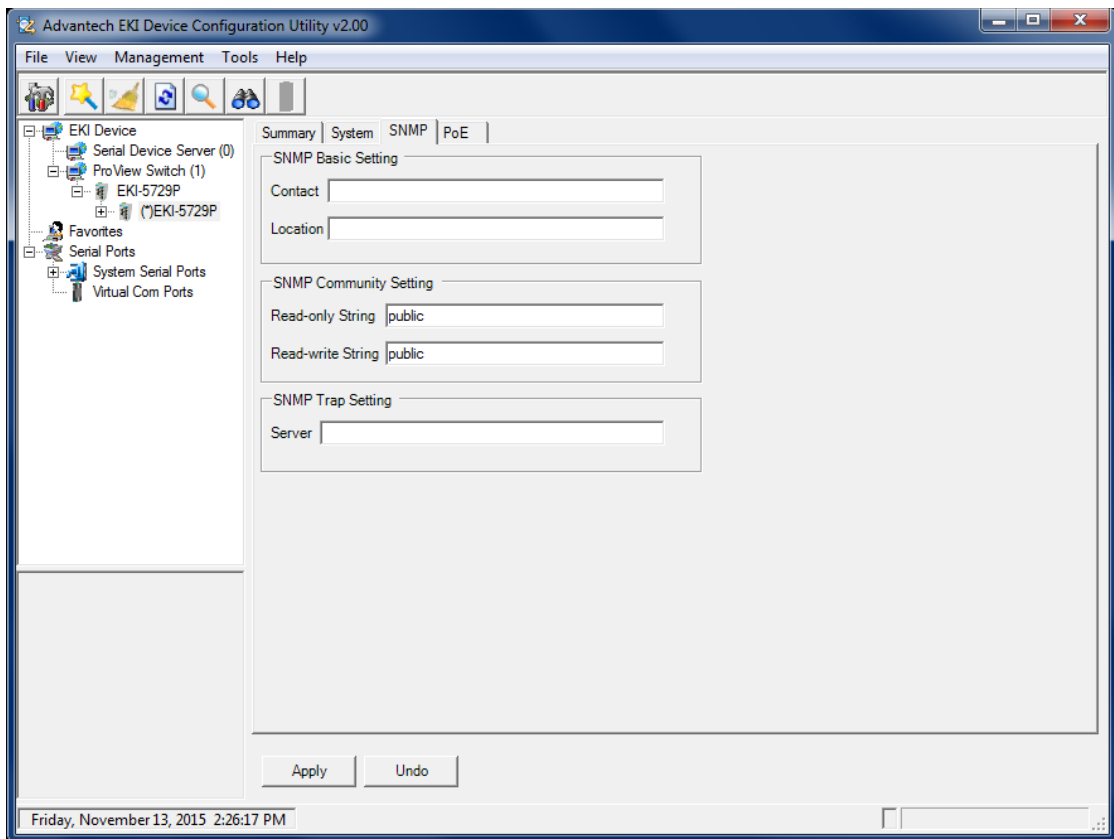

Figure 4.11 Setting SNMP

Setting PoE

1. Select the device to configure by clicking on it.
2. In the Configuration Area, select the **PoE** tab.
3. Select the radio-box next to the target port then click on it to check and enable the PoE function on that port. To disable the PoE function on the port, click on the radio-box to unselect it.
4. Click **Refresh** to update the PoE status for each port. Each port displays the current enabled or disabled state in addition to the following information.
 - Voltage (V)
 - Current (mA)
 - Power (W)

– Temperature (Celsius)

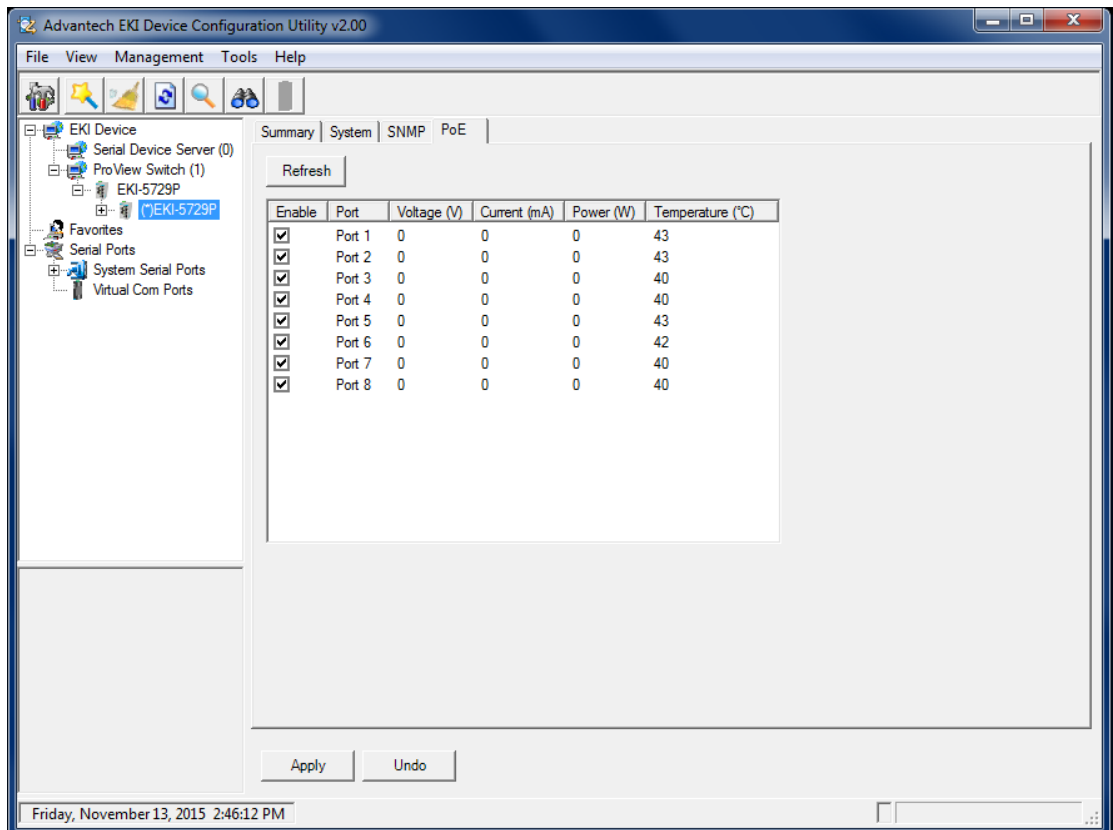

Figure 4.12 Setting Modbus/TCP Idle Time

4.2 Modbus/TCP Mapping

The data map addresses of Advantech switches shown in the following table start from Modbus address 30001 for function code 4.

In the given example, the address offset 0x1000 (hex) equals Modbus address 34097, while the address offset 0x1100 (hex) equals Modbus address 34353.

The information given by the Advantech is shown in hex mode.

4.2.1 Modbus/TCP Mapping Table

Catalog	Name	Data Type		Interpretation	Address Offset (Hex)	Address 3X	Description
System Info	Vendor ID = 0x'13FE	1 word	16 bits	HEX	0x0000	30001	Vendor ID = 0x13FE
	Unit ID = 0xFF	1 word	16 bits	HEX	0x0001	30002	Unit ID = 0xFF
	Product Code	1 word	16 bits	HEX	0x0002	30003	Product Code
	Vendor Name = "Advantech"	16 words	32 chars	ASCII	0x0010	30017	Vendor Name = "Advantech" Word 0 Hi byte = 'A' Word 0 Lo byte = 'd' Word 1 Hi byte = 'v' Word 1 Lo byte = 'a' Word 2 Hi byte = 'n' Word 2 Lo byte = 't' Word 3 Hi byte = 'e' Word 3 Lo byte = 'c' Word 4 Hi byte = 'h' Word 4 Lo byte = '\0'
	Product Name = "EKI-xxxx"	16 words	32 chars	ASCII	0x0020	30033	Product Name = "EKI-xxxx" Word 0 Hi byte = 'E' Word 0 Lo byte = 'K' Word 1 Hi byte = 'I' Word 1 Lo byte = '-' Word 2 Hi byte = 'x' Word 2 Lo byte = 'x' Word 3 Hi byte = 'x' Word 3 Lo byte = 'x' Word 4 Hi byte = '\0'

Catalog	Name	Data Type	Interpretation	Address Offset (Hex)	Address 3X	Description
System Info	Firmware Version	2 words 32 bits	HEX	0x020A	30523	Firmware Version Word 0 Hi byte = major Word 0 Lo byte = minor Word 1 Hi byte = release Word 1 Lo byte = build
	Ethernet MAC Address	3 words 48 bits	HEX	0x020E	30527	Ethernet MAC Address Ex: MAC = 00-19-CB-01-02-03 Word 0 Hi byte = 0x00 Word 0 Lo byte = 0x19 Word 1 Hi byte = 0xCB Word 1 Lo byte = 0x01 Word 2 Hi byte = 0x02 Word 2 Lo byte = 0x03
	Revision Number	16 words 32 chars	ASCII	0x0211	30530	Product Name = "YYY.xxxxx" Word 0 Hi byte = 'Y' Word 0 Lo byte = 'Y' Word 1 Hi byte = 'Y' Word 1 Lo byte = '.' Word 2 Hi byte = 'x' Word 2 Lo byte = 'x' Word 3 Hi byte = 'x' Word 3 Lo byte = 'x' Word 4 Hi byte = 'x' Word 4 Lo byte = '\0'
	IP Address	2 words 32 bits	HEX	0x0400	31025	IP Address Ex: IP = 192.168.1.1 Word 0 Hi byte = 0xC0 Word 0 Lo byte = 0xA8 Word 1 Hi byte = 0x01 Word 1 Lo byte = 0x01
Port Info	Port Status	1 word 16 bits	HEX	0x1000 ~ 0x101F	34097 ~ 34128	Port Status 0x0000: Link down 0x0001: Link up 0xFFFF: No port
	Port 1 Status	1 word 16 bits	HEX	0x1000	34097	
	Port 2 Status	1 word 16 bits	HEX	0x1001	34098	
	Port 3 Status	1 word 16 bits	HEX	0x1002	34099	

Catelog	Name	Data Type	Interpr etation	Address Offset (Hex)	Address 3X	Description	
Port Info	Port 4 Sta- tus	1 word	16 bits	HEX	0x1003	34100	
	Port 5 Sta- tus	1 word	16 bits	HEX	0x1004	34101	
	Port 6 Sta- tus	1 word	16 bits	HEX	0x1005	34102	
	Port 7 Sta- tus	1 word	16 bits	HEX	0x1006	34103	
	Port 8 Sta- tus	1 word	16 bits	HEX	0x1007	34104	
	Port 9 Sta- tus	1 word	16 bits	HEX	0x1008	34105	
	Port 10 Status	1 word	16 bits	HEX	0x1009	34106	
	Port Speed	1 word	16 bits	HEX	0x1100 ~ 0x111F	34353 ~ 34384	Port Speed 0x0000: 10M-Half 0x0001: 10M-Full 0x0002: 100M-Half 0x0003: 100M-Full 0x0004: 1000M-Half 0x0005: 1000M-Full 0xFFFF: No port
	Port 1 Speed	1 word	16 bits	HEX	0x1100	34353	
	Port 2 Speed	1 word	16 bits	HEX	0x1101	34354	
	Port 3 Speed	1 word	16 bits	HEX	0x1102	34355	
	Port 4 Speed	1 word	16 bits	HEX	0x1103	34356	
	Port 5 Speed	1 word	16 bits	HEX	0x1104	34357	
	Port 6 Speed	1 word	16 bits	HEX	0x1105	34358	
	Port 7 Speed	1 word	16 bits	HEX	0x1106	34359	
	Port 8 Speed	1 word	16 bits	HEX	0x1107	34360	
	Port 9 Speed	1 word	16 bits	HEX	0x1108	34361	
	Port 10 Speed	1 word	16 bits	HEX	0x1109	34362	

Catalog	Name	Data Type		Interpretation	Address Offset (Hex)	Address 3X	Description
Port Info	Port Description	20 words	40 chars	ASCII	0x1400 ~ 0x166C	35121 ~ 35741	Port Description = "100RX,RJ45." Word 0 Hi byte = '1' Word 0 Lo byte = '0' Word 1Hi byte = '0' Word 1 Lo byte = 'R' Word 2 Hi byte = 'X' Word 2 Lo byte = ',' Word 3 Hi byte = 'R' Word 3 Lo byte = 'J' Word 4 Hi byte = '4' Word 4 Lo byte = '5' Word 5 Hi byte = '.' Word 5 Lo byte = '\0'
	Port 1 Description	20 words	40 chars	ASCII	0x1400	35121	
	Port 2 Description	20 words	40 chars	ASCII	0x1414	35141	
	Port 3 Description	20 words	40 chars	ASCII	0x1428	35161	
	Port 4 Description	20 words	40 chars	ASCII	0x143C	35181	
	Port 5 Description	20 words	40 chars	ASCII	0x1450	35201	
	Port 6 Description	20 words	40 chars	ASCII	0x1464	35221	
	Port 7 Description	20 words	40 chars	ASCII	0x1478	35241	
	Port 8 Description	20 words	40 chars	ASCII	0x148C	35261	
	Port 9 Description	20 words	40 chars	ASCII	0x14A0	35281	
	Port 10 Description	20 words	40 chars	ASCII	0x14B4	35301	

Catalog	Name	Data Type	Interpretation	Address Offset (Hex)	Address 3X	Description
Port Info	Link Up Counter	1 word	16 bits	HEX	0x1700 ~ 0x171F	35889 ~ 35920 Link Up Counter Ex: port link up counter = 13 Received MODBUS response: 0x000D
	Port 1 Link Up Counter	1 word	16 bits	HEX	0x1700	35889
	Port 2 Link Up Counter	1 word	16 bits	HEX	0x1701	35890
	Port 3 Link Up Counter	1 word	16 bits	HEX	0x1702	35891
	Port 4 Link Up Counter	1 word	16 bits	HEX	0x1703	35892
	Port 5 Link Up Counter	1 word	16 bits	HEX	0x1704	35893
	Port 6 Link Up Counter	1 word	16 bits	HEX	0x1705	35894
	Port 7 Link Up Counter	1 word	16 bits	HEX	0x1706	35895
	Port 8 Link Up Counter	1 word	16 bits	HEX	0x1707	35896
	Port 9 Link Up Counter	1 word	16 bits	HEX	0x1708	35897
	Port 10 Link Up Counter	1 word	16 bits	HEX	0x1709	35898
	PoE Voltage	1 word	16 bits	HEX	0x1800 ~ 0x181F	36145 ~ 36176 PoE Voltage (V) Ex: poe voltage = 5 Received MODBUS response: 0x0005
	Port 1 PoE Voltage	1 word	16 bits	HEX	0x1800	36145
	Port 2 PoE Voltage	1 word	16 bits	HEX	0x1801	36146
	Port 3 PoE Voltage	1 word	16 bits	HEX	0x1802	36147
	Port 4 PoE Voltage	1 word	16 bits	HEX	0x1803	36148

Catalog	Name	Data Type	Interpretation	Address Offset (Hex)	Address 3X	Description
Port Info	Port 5 PoE Voltage	1 word	16 bits	HEX	0x1804	36149
	Port 6 PoE Voltage	1 word	16 bits	HEX	0x1805	36150
	Port 7 PoE Voltage	1 word	16 bits	HEX	0x1806	36151
	Port 8 PoE Voltage	1 word	16 bits	HEX	0x1807	36152
	Port 9 PoE Voltage	1 word	16 bits	HEX	0x1808	36153
	Port 10 PoE Voltage	1 word	16 bits	HEX	0x1809	36154
	PoE Current	1 word	16 bits	HEX	0x1820 ~ ~ 0x183F	36177 ~ 36208 PoE Current (mA) Ex: poe current = 13 Received MODBUS response: 0x000D
	Port 1 PoE Current	1 word	16 bits	HEX	0x1820	36177
	Port 2 PoE Current	1 word	16 bits	HEX	0x1821	36178
	Port 3 PoE Current	1 word	16 bits	HEX	0x1822	36179
	Port 4 PoE Current	1 word	16 bits	HEX	0x1823	36180
	Port 5 PoE Current	1 word	16 bits	HEX	0x1824	36181
	Port 6 PoE Current	1 word	16 bits	HEX	0x1825	36182
	Port 7 PoE Current	1 word	16 bits	HEX	0x1826	36183
	Port 8 PoE Current	1 word	16 bits	HEX	0x1827	36184
	Port 9 PoE Current	1 word	16 bits	HEX	0x1828	36185
	Port 10 PoE Current	1 word	16 bits	HEX	0x1829	36186
	PoE Power	1 word	16 bits	HEX	0x1840 ~ ~ 0x185F	36209 ~ 36240 PoE Power (W) Ex: poe power = 10 Received MODBUS response: 0x000A
	Port 1 PoE Power	1 word	16 bits	HEX	0x1840	36209
	Port 2 PoE Power	1 word	16 bits	HEX	0x1841	36210
	Port 3 PoE Power	1 word	16 bits	HEX	0x1842	36211
	Port 4 PoE Power	1 word	16 bits	HEX	0x1843	36212

Catelog	Name	Data Type	Interpretation	Address Offset (Hex)	Address 3X	Description
	Port 5 PoE Power	1 word	16 bits	HEX	0x1844	36213
	Port 6 PoE Power	1 word	16 bits	HEX	0x1845	36214
	Port 7 PoE Power	1 word	16 bits	HEX	0x1846	36215
	Port 8 PoE Power	1 word	16 bits	HEX	0x1847	36216
	Port 9 PoE Power	1 word	16 bits	HEX	0x1848	36217
	Port 10 PoE Power	1 word	16 bits	HEX	0x1849	36218
	PoE Temperature	1 word	16 bits	HEX	0x1860 ~ 0x187F	36241 ~ 36272 PoE Temperature (C) Ex: poe temperature = 32 Received MODBUS response: 0x0020
	Port 1 PoE Temperature	1 word	16 bits	HEX	0x1860	36241
	Port 2 PoE Temperature	1 word	16 bits	HEX	0x1861	36242
Port Info	Port 3 PoE Temperature	1 word	16 bits	HEX	0x1862	36243
	Port 4 PoE Temperature	1 word	16 bits	HEX	0x1863	36244
	Port 5 PoE Temperature	1 word	16 bits	HEX	0x1864	36245
	Port 6 PoE Temperature	1 word	16 bits	HEX	0x1865	36246
	Port 7 PoE Temperature	1 word	16 bits	HEX	0x1866	36247
	Port 8 PoE Temperature	1 word	16 bits	HEX	0x1867	36248
	Port 9 PoE Temperature	1 word	16 bits	HEX	0x1868	36249
	Port 10 PoE Temperature	1 word	16 bits	HEX	0x1869	36250

Catalog	Name	Data Type	Interpretation	Address Offset (Hex)	Address 3X	Description
Packet Info	TxPackets Counter	4 words 64 bits	HEX	0x2000 ~ 0x207C	38193 ~ 38317	Tx Packets Ex: port 1 Tx Packet Amount = 11223344 Received MODBUS response: 0xAB4130 Word 0 = 0x0000 Word 1 = 0x0000 Word 2 = 0x00AB Word 3 = 0x4130
	Port 1 Tx Packets	4 words 64 bits	HEX	0x2000	38193	
	Port 2 Tx Packets	4 words 64 bits	HEX	0x2004	38197	
	Port 3 Tx Packets	4 words 64 bits	HEX	0x2008	38201	
	Port 4 Tx Packets	4 words 64 bits	HEX	0x200C	38205	
	Port 5 Tx Packets	4 words 64 bits	HEX	0x2010	38209	
Packet Info	Port 6 Tx Packets	4 words 64 bits	HEX	0x2014	38213	
	Port 7 Tx Packets	4 words 64 bits	HEX	0x2018	38217	
	Port 8 Tx Packets	4 words 64 bits	HEX	0x201C	38221	
	Port 9 Tx Packets	4 words 64 bits	HEX	0x2020	38225	
	Port 10 Tx Packets	4 words 64 bits	HEX	0x2024	38229	
Packet Info	Rx Packets Counter	4 words 64 bits	HEX	0x2100 ~ 0x217C	38449 ~ 38573	Rx Packets Ex: port 1 Rx Packet Amount = 11223344 Received MODBUS response: 0xAB4130 Word 0 = 0x0000 Word 1 = 0x0000 Word 2 = 0x00AB Word 3 = 0x4130
	Port 1 Rx Packets	4 words 64 bits	HEX	0x2100	38449	
	Port 2 Rx Packets	4 words 64 bits	HEX	0x2104	38453	
	Port 3 Rx Packets	4 words 64 bits	HEX	0x2108	38457	
	Port 4 Rx Packets	4 words 64 bits	HEX	0x210C	38461	
	Port 5 Rx Packets	4 words 64 bits	HEX	0x2110	38465	

Catelog	Name	Data Type	Interpr etation	Address Offset (Hex)	Address 3X	Description
	Port 6 Rx Packets	4 words 64 bits	HEX	0x2114	38469	
	Port 7 Rx Packets	4 words 64 bits	HEX	0x2118	38473	
	Port 8 Rx Packets	4 words 64 bits	HEX	0x211C	38477	
Packet Info	Port 9 Rx Packets	4 words 64 bits	HEX	0x2120	38481	
	Port 10 Rx Packets	4 words 64 bits	HEX	0x2124	38485	
	Tx Error Packets Counter	2 words 32 bits	HEX	0x2200 ~ 0x223E	38705 ~ 38767	Tx Error Packets Ex: port 1 Tx Packet Amount = 11223344 Received MODBUS response: 0xAB4130 Word 0 = 0x00AB Word 1 = 0x4130
	Port 1 Tx Error Packets	2 words 32 bits	HEX	0x2200	38705	
	Port 2 Tx Error Packets	2 words 32 bits	HEX	0x2202	38707	
	Port 3 Tx Error Packets	2 words 32 bits	HEX	0x2204	38709	
	Port 4 Tx Error Packets	2 words 32 bits	HEX	0x2206	38711	
	Port 5 Tx Error Packets	2 words 32 bits	HEX	0x2208	38713	
	Port 6 Tx Error Packets	2 words 32 bits	HEX	0x220A	38715	
	Port 7 Tx Error Packets	2 words 32 bits	HEX	0x220C	38717	
	Port 8 Tx Error Packets	2 words 32 bits	HEX	0x220E	38719	
	Port 9 Tx Error Packets	2 words 32 bits	HEX	0x2210	38721	
Packet Info	Port 10 Tx Error Packets	2 words 32 bits	HEX	0x2212	38723	

Catalog	Name	Data Type	Interpretation	Address Offset (Hex)	Address 3X	Description
	Rx Error Packets Counter	2 words 32 bits	HEX	0x2300 ~ 0x233E	38961 ~ 39023	Rx Error Packets Ex: port 1 Rx Packet Amount = 11223344 Received MODBUS response: 0xAB4130 Word 0 = 0x00AB Word 1 = 0x4130
	Port 1 Rx Error Packets	2 words 32 bits	HEX	0x2300	38961	
	Port 2 Rx Error Packets	2 words 32 bits	HEX	0x2302	38963	
	Port 3 Rx Error Packets	2 words 32 bits	HEX	0x2304	38965	
Packet Info	Port 4 Rx Error Packets	2 words 32 bits	HEX	0x2306	38967	
	Port 5 Rx Error Packets	2 words 32 bits	HEX	0x2308	38969	
	Port 6 Rx Error Packets	2 words 32 bits	HEX	0x230A	38971	
	Port 7 Rx Error Packets	2 words 32 bits	HEX	0x230C	38973	
	Port 8 Rx Error Packets	2 words 32 bits	HEX	0x230E	38975	
	Port 9 Rx Error Packets	2 words 32 bits	HEX	0x2310	38977	
	Port 10 Rx Error Packets	2 words 32 bits	HEX	0x2312	38979	

ADVANTECH

Enabling an Intelligent Planet

www.advantech.com

Please verify specifications before quoting. This guide is intended for reference purposes only.

All product specifications are subject to change without notice.

No part of this publication may be reproduced in any form or by any means, electronic, photocopying, recording or otherwise, without prior written permission of the publisher.

All brand and product names are trademarks or registered trademarks of their respective companies.

© Advantech Co., Ltd. 2007