

User Manual

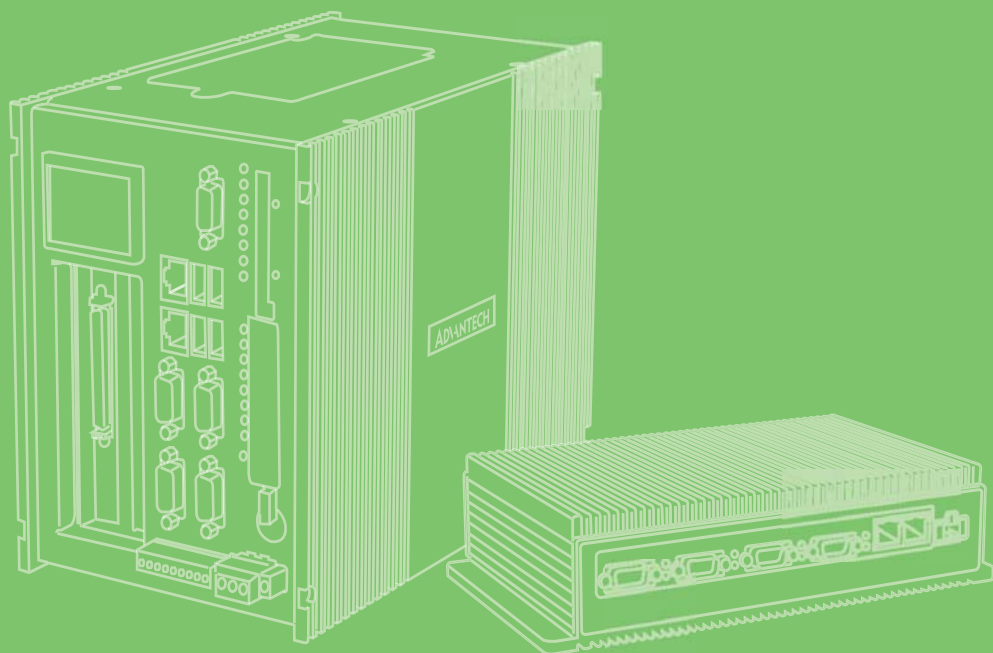

UNO-2484G

電腦

Intel® Core™ i Standard-Size
Automation Computer with 4 x
GbE, 1 x mPCIe, HDMI, DP, 4 x
USB3.0, 4 x COM

ADVANTECH

Enabling an Intelligent Planet

限用物質含有情況標示聲明書

Declaration of the Presence Condition of the Restricted Substances Marking

設備名稱： Equipment name		電腦		型號（型式）： Type designation		UNO-2484G (系列型號請參見次頁說明書)	
單元 Unit	限用物質及其化學符號 Restricted substances and its chemical symbols						
	鉛Lead (Pb)	汞Mercury (Hg)	鎘Cadmium (Cd)	六價鉻 Hexavalent chromium (Cr ⁺⁶)	多溴聯苯 Polybrominated biphenyls (PBB)	多溴二苯醚 Polybrominated diphenyl ethers (PBDE)	
電路板	—	○	○	○	○	○	
內外殼 (外殼、內 部框架… 等)	○	○	○	○	○	○	
其它固定 組件 (螺絲)	—	○	○	○	○	○	
記憶卡	—	○	○	○	○	○	
<p>備考1. “超出0.1 wt %”及“超出0.01 wt %”係指限用物質之百分比含量超出百分比含量基準值。 Note 1: “Exceeding 0.1 wt %” and “exceeding 0.01 wt %” indicate that the percentage content of the restricted substance exceeds the reference percentage value of presence condition.</p> <p>備考2. “○”係指該項限用物質之百分比含量未超出百分比含量基準值。 Note 2: “○” indicates that the percentage content of the restricted substance does not exceed the percentage of reference value of presence.</p> <p>備考3. “—”係指該項限用物質為排除項目。 Note 3: The “—” indicates that the restricted substance corresponds to the exemption.</p>							

限用物質含有情況標示聲明書

Declaration of the Presence Condition of the Restricted Substances Marking

設備名稱： Equipment name		電腦		型號（型式）： Type designation		UNO2484G (系列型號請參見次頁說明書)	
單元 Unit	限用物質及其化學符號 Restricted substances and its chemical symbols						
	鉛Lead (Pb)	汞Mercury (Hg)	鎘Cadmium (Cd)	六價鉻 Hexavalent chromium (Cr ⁺⁶)	多溴聯苯 Polybrominated biphenyls (PBB)	多溴二苯醚 Polybrominated diphenyl ethers (PBDE)	
電路板	—	○	○	○	○	○	
內外殼 (外殼、內 部框架… 等)	○	○	○	○	○	○	
其它固定 組件 (螺絲)	—	○	○	○	○	○	
記憶卡	—	○	○	○	○	○	
<p>備考1. “超出0.1 wt %”及“超出0.01 wt %”係指限用物質之百分比含量超出百分比含量基準值。 Note 1: “Exceeding 0.1 wt %” and “exceeding 0.01 wt %” indicate that the percentage content of the restricted substance exceeds the reference percentage value of presence condition.</p> <p>備考2. “○”係指該項限用物質之百分比含量未超出百分比含量基準值。 Note 2: “○” indicates that the percentage content of the restricted substance does not exceed the percentage of reference value of presence.</p> <p>備考3. “—”係指該項限用物質為排除項目。 Note 3: The “—” indicates that the restricted substance corresponds to the exemption.</p>							

Copyright

The documentation and the software included with this product are copyrighted 2017 by Advantech Co., Ltd. All rights are reserved. Advantech Co., Ltd. reserves the right to make improvements in the products described in this manual at any time without notice. No part of this manual may be reproduced, copied, translated or transmitted in any form or by any means without the prior written permission of Advantech Co., Ltd. Information provided in this manual is intended to be accurate and reliable. However, Advantech Co., Ltd. assumes no responsibility for its use, nor for any infringements of the rights of third parties, which may result from its use.

Acknowledgements

IBM, PC/AT, PS/2 and VGA are trademarks of International Business Machines Corporation.

Intel®, Core™ and Atom™ are the trademarks of Intel Corporation

Microsoft Windows and MS-DOS are registered trademarks of Microsoft Corp.

All other product names or trademarks are properties of their respective owners.

Support

For more information on this and other Advantech products, please visit our websites at: <http://www.advantech.com>

For technical support and service, please visit our support website at:
<http://support.advantech.com/>

UNO-2484G, UNO2484G
UNO-2484G-6731AE, UNO-2484G-6731AE,
UNO-2484G-6531AE, UNO-2484G-6532AE,
UNO-2484G-6331AE, UNO-2484G-6332AE,
UNO2484G6731701E-T, UNO2484G6731702E-T, UNO2484G6731703E-T,
UNO2484G6731704E-T, UNO2484G6731705E-T, UNO2484G6731706E-T,
UNO2484G6731707E-T, UNO2484G6731708E-T, UNO2484G6731709E-T,
UNO2484G6731801E-T, UNO2484G6731802E-T, UNO2484G6731803E-T,
UNO2484G6731804E-T, UNO2484G6731805E-T, UNO2484G6731806E-T,
UNO2484G6731807E-T, UNO2484G6731808E-T, UNO2484G6731809E-T,
UNO2484G6731901E-T, UNO2484G6731902E-T, UNO2484G6731903E-T,
UNO2484G6731904E-T, UNO2484G6731905E-T, UNO2484G6731906E-T,
UNO2484G6731907E-T, UNO2484G6731908E-T, UNO2484G6731909E-T,
UNO2484G6732001E-T, UNO2484G6732002E-T, UNO2484G6732003E-T,
UNO2484G6732004E-T, UNO2484G6732005E-T, UNO2484G6732006E-T,
UNO2484G6732007E-T, UNO2484G6732008E-T, UNO2484G6732009E-T,
UNO2484G6732101E-T, UNO2484G6732102E-T, UNO2484G6732103E-T,
UNO2484G6732104E-T, UNO2484G6732105E-T, UNO2484G6732106E-T,
UNO2484G6732107E-T, UNO2484G6732108E-T, UNO2484G6732109E-T,
UNO2484G6732201E-T, UNO2484G6732202E-T, UNO2484G6732203E-T,
UNO2484G6732204E-T, UNO2484G6732205E-T, UNO2484G6732206E-T,
UNO2484G6732207E-T, UNO2484G6732208E-T, UNO2484G6732209E-T,
UNO2484G6531701E-T, UNO2484G6531702E-T, UNO2484G6531703E-T,
UNO2484G6531704E-T, UNO2484G6531705E-T, UNO2484G6531706E-T,
UNO2484G6531707E-T, UNO2484G6531708E-T, UNO2484G6531709E-T,
UNO2484G6531801E-T, UNO2484G6531802E-T, UNO2484G6531803E-T,
UNO2484G6531804E-T, UNO2484G6531805E-T, UNO2484G6531806E-T,
UNO2484G6531807E-T, UNO2484G6531808E-T, UNO2484G6531809E-T,
UNO2484G6531901E-T, UNO2484G6531902E-T, UNO2484G6531903E-T,
UNO2484G6531904E-T, UNO2484G6531905E-T, UNO2484G6531906E-T,
UNO2484G6531907E-T, UNO2484G6531908E-T, UNO2484G6531909E-T,
UNO2484G6532001E-T, UNO2484G6532002E-T, UNO2484G6532003E-T,
UNO2484G6532004E-T, UNO2484G6532005E-T, UNO2484G6532006E-T,
UNO2484G6532007E-T, UNO2484G6532008E-T, UNO2484G6532009E-T,
UNO2484G6532101E-T, UNO2484G6532102E-T, UNO2484G6532103E-T,
UNO2484G6532104E-T, UNO2484G6532105E-T, UNO2484G6532106E-T,
UNO2484G6532107E-T, UNO2484G6532108E-T, UNO2484G6532109E-T,
UNO2484G6532201E-T, UNO2484G6532202E-T, UNO2484G6532203E-T,
UNO2484G6532204E-T, UNO2484G6532205E-T, UNO2484G6532206E-T,
UNO2484G6532207E-T, UNO2484G6532208E-T, UNO2484G6532209E-T,
UNO2484G6331701E-T, UNO2484G6331702E-T, UNO2484G6331703E-T,
UNO2484G6331704E-T, UNO2484G6331705E-T, UNO2484G6331706E-T,
UNO2484G6331707E-T, UNO2484G6331708E-T, UNO2484G6331709E-T,
UNO2484G6331801E-T, UNO2484G6331802E-T, UNO2484G6331803E-T,
UNO2484G6331804E-T, UNO2484G6331805E-T, UNO2484G6331806E-T,

UNO2484G6331807E-T, UNO2484G6331808E-T, UNO2484G6331809E-T,
UNO2484G6331901E-T, UNO2484G6331902E-T, UNO2484G6331903E-T,
UNO2484G6331904E-T, UNO2484G6331905E-T, UNO2484G6331906E-T,
UNO2484G6331907E-T, UNO2484G6331908E-T, UNO2484G6331909E-T,
UNO2484G6332001E-T, UNO2484G6332002E-T, UNO2484G6332003E-T,
UNO2484G6332004E-T, UNO2484G6332005E-T, UNO2484G6332006E-T,
UNO2484G6332007E-T, UNO2484G6332008E-T, UNO2484G6332009E-T,
UNO2484G6332101E-T, UNO2484G6332102E-T, UNO2484G6332103E-T,
UNO2484G6332104E-T, UNO2484G6332105E-T, UNO2484G6332106E-T,
UNO2484G6332107E-T, UNO2484G6332108E-T, UNO2484G6332109E-T,
UNO2484G6332201E-T, UNO2484G6332202E-T, UNO2484G6332203E-T,
UNO2484G6332204E-T, UNO2484G6332205E-T, UNO2484G6332206E-T,
UNO2484G6332207E-T, UNO2484G6332208E-T, UNO2484G6332209E-T,

Product Warranty (2 years)

Advantech warrants to you, the original purchaser, that each of its products will be free from defects in materials and workmanship for two years from the date of purchase.

This warranty does not apply to any products which have been repaired or altered by persons other than repair personnel authorized by Advantech, or which have been subject to misuse, abuse, accident or improper installation. Advantech assumes no liability under the terms of this warranty as a consequence of such events.

Because of Advantech's high quality-control standards and rigorous testing, most of our customers never need to use our repair service. If an Advantech product is defective, it will be repaired or replaced at no charge during the warranty period. For out-of-warranty repairs, you will be billed according to the cost of replacement materials, service time and freight. Please consult your dealer for more details.

If you think you have a defective product, follow these steps:

1. Collect all the information about the problem encountered. (For example, CPU speed, Advantech products used, other hardware and software used, etc.) Note anything abnormal and list any onscreen messages you get when the problem occurs.
2. Call your dealer and describe the problem. Please have your manual, product, and any helpful information readily available.
3. If your product is diagnosed as defective, obtain an RMA (return merchandise authorization) number from your dealer. This allows us to process your return more quickly.
4. Carefully pack the defective product, a fully-completed Repair and Replacement Order Card and a photocopy proof of purchase date (such as your sales receipt) in a shippable container. A product returned without proof of the purchase date is not eligible for warranty service.
5. Write the RMA number visibly on the outside of the package and ship it prepaid to your dealer.

Declaration of Conformity

CE

This product has passed the CE test for environmental specifications when shielded cables are used for external wiring. We recommend the use of shielded cables. This kind of cable is available from Advantech. Please contact your local supplier for ordering information.

FCC Class A

Note: This equipment has been tested and found to comply with the limits for a Class A digital device, pursuant to part 15 of the FCC Rules. These limits are designed to provide reasonable protection against harmful interference when the equipment is operated in a commercial environment. This equipment generates, uses, and can radiate radio frequency energy and, if not installed and used in accordance with the instruction manual, may cause harmful interference to radio communications. Operation of this equipment in a residential area is likely to cause harmful interference in which case the user will be required to correct the interference at his own expense.

警告使用者

這是甲類測試產品，在居住的環境中使用時，可能會造成射頻干擾，在這種情況下，使用者會被要求採取某些適當的對策。

Technical Support and Assistance

1. Visit the Advantech web site at www.advantech.com/support where you can find the latest information about the product.
2. Contact your distributor, sales representative, or Advantech's customer service center for technical support if you need additional assistance. Please have the following information ready before you call:
 - Product name and serial number
 - Description of your peripheral attachments
 - Description of your software (operating system, version, application software, etc.)
 - A complete description of the problem
 - The exact wording of any error messages

Safety Precaution - Static Electricity

Follow these simple precautions to protect yourself from harm and the products from damage.

- To avoid electrical shock, always disconnect the power from your PC chassis before you work on it. Don't touch any components on the CPU card or other cards while the PC is on.
- Disconnect power before making any configuration changes. The sudden rush of power as you connect a jumper or install a card may damage sensitive electronic components.

Safety Instructions

1. Read these safety instructions carefully.
2. Keep this User Manual for later reference.
3. Disconnect this equipment from any AC outlet before cleaning. Use a damp cloth. Do not use liquid or spray detergents for cleaning.
4. For plug-in equipment, the power outlet socket must be located near the equipment and must be easily accessible.
5. Keep this equipment away from humidity.
6. Put this equipment on a reliable surface during installation. Dropping it or letting it fall may cause damage.
7. The openings on the enclosure are for air convection. Protect the equipment from overheating. **DO NOT COVER THE OPENINGS.**
8. Make sure the voltage of the power source is correct before connecting the equipment to the power outlet.
9. Position the power cord so that people cannot step on it. Do not place anything over the power cord.
10. All cautions and warnings on the equipment should be noted.
11. If the equipment is not used for a long time, disconnect it from the power source to avoid damage by transient overvoltage.
12. Never pour any liquid into an opening. This may cause fire or electrical shock.
13. Never open the equipment. For safety reasons, the equipment should be opened only by qualified service personnel.
14. If one of the following situations arises, get the equipment checked by service personnel:
 - The power cord or plug is damaged.
 - Liquid has penetrated into the equipment.
 - The equipment has been exposed to moisture.
 - The equipment does not work well, or you cannot get it to work according to the user's manual.
 - The equipment has been dropped and damaged.
 - The equipment has obvious signs of breakage.
15. **DO NOT LEAVE THIS EQUIPMENT IN AN ENVIRONMENT WHERE THE STORAGE TEMPERATURE MAY GO BELOW -20°C (-4°F) ~ 60°C (140°F) for UNO-2484G.**
16. **CAUTION: DANGER OF EXPLOSION IF BATTERY IS INCORRECTLY REPLACED. REPLACE ONLY WITH THE SAME OR EQUIVALENT TYPE RECOMMENDED BY THE MANUFACTURER, DISCARD USED BATTERIES ACCORDING TO THE MANUFACTURER'S INSTRUCTIONS.**
17. **ATTENTION: Danger d'explosion si la batterie est mal REMPLACÉ. REMPLACER UNIQUEMENT PAR LE MEME TYPE OU EQUIVALENT RECOMMANDÉ PAR LE FABRICANT, jeter les piles usagées SELON LES INSTRUCTIONS DU FABRICANT.**
18. The sound pressure level at the operator's position according to IEC 704-1:1982 is no more than 70 dB (A).

DISCLAIMER: This set of instructions is given according to IEC 704-1. Advantech disclaims all responsibility for the accuracy of any statements contained herein.

安全指示

1. 請仔細閱讀此安全操作說明。
2. 請妥善保存此用戶手冊供日後參考。
3. 用濕抹布清洗設備前，請確認拔除電源線。請勿使用液體或去污噴霧劑清洗設備。
4. 對於使用電源線的設備，設備周圍必須有容易接觸到的電源插座。
5. 請勿在潮濕環境中試用設備。
6. 請在安裝前確保設備放置在可靠的平面上，意外摔落可能會導致設備損壞。
7. 設備機殼的開孔適用於空氣對，從而防止設備過熱。請勿覆蓋開孔。
8. 當您連接設備到電源插座前，請確認電源插座的電壓符合要求。
9. 請將電源線佈置在人們不易絆倒的位置，請勿在電源線上覆蓋任何雜物。
10. 請注意設備上所有的警告標示。
11. 如果長時間不使用設備，請拔除與電源插座的連結，避免設備被超標的電壓波動損壞。
12. 請勿讓任何液體流入通風口，以免引起火災或短路。
13. 請勿自行打開設備。為了確保您的安全，請透過經認證的工程師來打開設備。
14. 如遇下列情況，請由專業人員維修：
 - 電源線或插頭損壞；
 - 設備內部有液體流入；
 - 設備曾暴露在過度潮濕環境中使用；
 - 設備無法正常工作，或您無法透過用戶手冊來正常工作；
 - 設備摔落或損壞；
 - 設備有明顯外觀損；
15. 請勿將設備放置在超出建議溫度範圍的環境，即不要低於 -20°C (-4°F) 或高於 60°C (140°F)，否則可能會造成設備損壞。
16. 注意：若電池更換不正確，將有爆炸危險。因此，只可以使用製造商推薦的同一種或者同等型號的電池進行替換。請按照製造商的指示處理舊電池。
17. 根據 IEC 704-1:1982 規定，操作員所在位置音量不可高於 70 分貝。
18. 限制區域：請勿將設備安裝於限制區域使用。
19. 免責聲明：請安全訓示符合 IEC 704-1 要求。研華公司對其內容之準確性不承擔任何法律責任。

Chapter	1	Overview	1
	1.1	Introduction	2
	1.2	Safety Precautions	2
	1.3	Accessories	3
Chapter	2	Hardware Functionality	5
	2.1	Introduction	6
		Figure 2.1 Front Panel of UNO-2484G for one stack model.....	6
		Figure 2.2 Front Panel of UNO2484G for two stack model which can support extra iDoor module	6
	2.2	UNO-2484G Interface	6
	2.2.1	COM Port Interface (COM1, COM2, COM3, COM4)	6
	2.3	LAN: Ethernet Connector	6
	2.4	Power Connector	6
	2.5	USB Connector	7
	2.6	RTC Battery Specification	7
	2.7	Power Button/Power Management	7
	2.8	Reset Button	7
	2.9	PCI Express Mini Card Socket.....	7
Chapter	3	Initial Setup	9
	3.1	Chassis Grounding.....	10
		Figure 3.1 Chassis Grounding Connection.....	10
	3.2	Connecting Power	10
Appendix A		System Settings/Pin Assignments ..	11
	A.1	CN10 Internal GPIO Pin Header	12
		Table A.1: CN10 Internal GPIO Pin Header	12
	A.2	Board Connectors and Jumpers	12
		Figure A.1 Connector & Jumper Locations (front).....	13
		Table A.2: Connectors and Jumpers	13
	A.3	Power Connector (PWR).....	14
		Table A.3: Power connector pin assignments.....	14
	A.4	DP Connector.....	14
		Table A.4: DisplayPort adaptor cable pin assignment	14
		Table A.5: USB 3.0 Connector Pin Assignments.....	15
	A.5	HDMI Display Connector.....	15
		Table A.6: HDMI Display Connector	15
	A.6	COM1/COM2/COM3/COM4 RS232/422/485 connector	15
	A.7	Mini PCIE slot (MINIPCIE)	17
	A.8	LAN RJ45 connector	18
	A.9	CN15/CN53 Internal USB2.0 Pin Header	19
		Table A.7: CN15/CN53 Internal USB2.0 Pin Header.....	19
	A.10	Screw Type and Quantity for Mounting Module	19

Chapter 1

Overview

This chapter provides an overview of UNO-2484G specifications.

Sections include:

- Introduction
- Safety precautions
- Accessories

1.1 Introduction

The UNO-2484G is an embedded Hardware Ready Platform that can shorten your development time. It offers a wide array of networking interfaces to fulfill the extensive needs of different projects. UNO-2484G includes Intel's latest Skylake Core-i technology and provides rich interfaces including up to 4 x GbE LAN and 4 x USB3.0 ports. The UNO-2484G supports one DP and one HDMI display and also Advantech's latest iDoor technology.

The UNO-2484G can operate in wide temperatures (from -20 to 60°C). The UNO-2484G uses Intel Core i CPUs and built-in 8G DDR4 RAM for heavy programs.

UNO-2484G provides great expansion including 1 x Mini-PCIe (or extra 3 x mPCIe with extension mini-card) support. With these expansions UNO-2484G has great expandability for Wi-Fi, 3G, I/O expansion and industrial protocols via iDoor technology.

With multiple OS and driver support, such as Windows 7, Windows 10 and embedded Linux, users can integrate applications easily in an application ready platform that can provide versatile functions to fulfill diverse requirements.

1.2 Safety Precautions

The following sections tell how to make each connection. In most cases, you will simply need to connect a standard cable.

Warning! *Always disconnect the power cord from your chassis whenever you are working on it. Do not connect while the power is on. A sudden rush of power can damage sensitive electronic components. Only experienced electronics personnel should open the chassis.*



Warning! *Toujours à la terre pour éliminer toute charge d'électricité statique avant toucher UNO-2484G. Appareils électroniques modernes sont très sensibles à charges d'électricité statique. Utilisez un bracelet antistatique à tout moment. Placez tous composants électroniques sur une surface antistatique ou dans un statique-sac blindé.*



Caution! *Always ground yourself to remove any static electric charge before touching UNO-2484G. Modern electronic devices are very sensitive to static electric charges. Use a grounding wrist strap at all times. Place all electronic components on a static-dissipative surface or in a static-shielded bag.*



Caution! *Toujours débrancher le cordon d'alimentation de votre boîtier lorsque vous êtes travailler. Ne branchez pas lorsque l'appareil est allumé. Un afflux soudain de puissance peut endommager les composants électroniques sensibles. Seulement connu personnel de l'électronique devraient ouvrir le châssis.*



1.3 Accessories

Please refer below for the accessory list:

- Pin connector for power wiring (Advantech P/N: 1652002209)
- Warranty card

If anything is missing or damaged, contact your distributor or sales representative immediately.

- Operating Temperature: -20 to 60°C
- Power Requirements: 10 - 36 V_{DC}
- Power Consumption: 55 W (Typical), 85 W (Max)
- System Hardware Specification
 - CPU: Skylake Core i7-6600U (2.6GHz), i5-6300U (2.4GHz), i3-6100U (2.3GHz)
 - Memory: 8G DDR4 2133MHz
 - Graphic Engine: Intel HD Graphic
 - Ethernet: Intel i210 GbE, 802.10av, IEEE1588/802.1AS, 803.3az
 - Storage:
 - Supports 2* SSD or HDD (RAID support)
 - 1 x full-size mSATA (support mPCIe)
 - Expansion: 1 x Full-size mPCIe slot (support extra 3 x Full-size mPCIe by 2nd extension mini-card)
 - Display: 1 x HDMI, support 1920 x 1080 @60Hz 24bpp, 1 x DP

Applicable Models:

UNO-2484G-6731AE
UNO-2484G-6732AE
UNO-2484G-6531AE
UNO-2484G-6532AE
UNO-2484G-6331AE
UNO-2484G-6332AE

Chapter 2

Hardware Functionality

This chapter shows how to setup the UNO-2484G's hardware functions, including connecting peripherals, setting switches and indicators.

Sections include:

- Introduction
- UNO-2484G Interface
- LAN / Ethernet Connector
- Power Connector
- USB Connector
- RTC Battery Specification
- Power Button/Power Management
- Reset Bottom
- PCI Express Mini Card Socket

2.1 Introduction

The following figures show the connectors on UNO-2484G. The following sections give you information about each peripheral.

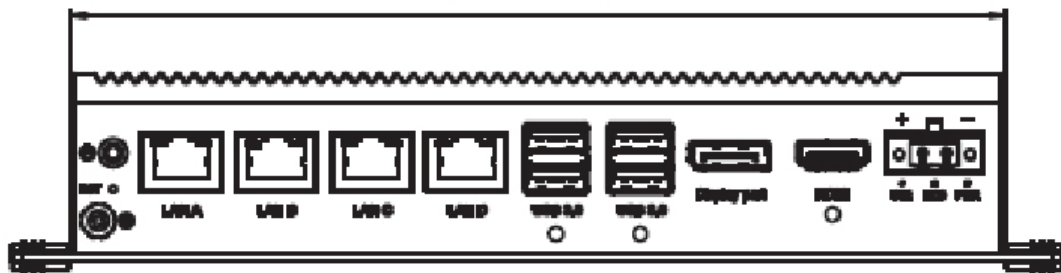

Figure 2.1 Front Panel of UNO-2484G for one stack model.

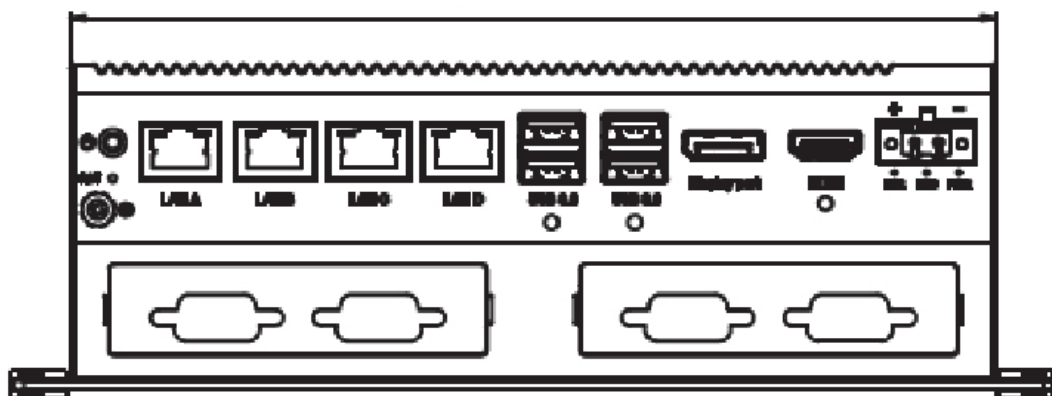

Figure 2.2 Front Panel of UNO2484G for two stack model which can support extra iDoor module

2.2 UNO-2484G Interface

The UNO-2484G has four standard COM serial communication ports: COM1, COM2, COM3, COM4. The setting can be adjusted in the BIOS page, the driver will be installed automatically during OS installation.

2.2.1 COM Port Interface (COM1, COM2, COM3, COM4)

For UNO-2484G, 4 x RS-232/422/485, DB9, 50~115.2kbps.

2.3 LAN: Ethernet Connector

UNO-2484G is equipped with a four Gigabit LAN controller. The controller chip used is an Intel i210 Ethernet controller that is fully compliant with IEEE 802.3u 10/100/1000 Base-T. The Ethernet port is a standard RJ-45 jack, and LED indicators are on the front to show its Link (Green LED) and Active (Green LED) status.

2.4 Power Connector

UNO-2484G comes with a Phoenix connector that carries 10 - 36 V_{DC} external power input, and features reversed wiring protection. Therefore, it will not cause any

damage to the system by reversed wiring of ground and power lines. Refer to Appendix A.4.

2.5 USB Connector

The USB interface supports Plug and Play, which enables you to connect or disconnect a device whenever you want, without turning off the computer. The UNO-2484G provides four USB connectors, which gives complete Plug & Play and hot swapping for up to 127 external devices. The USB interface can be disabled in the system BIOS. For the UNO-2484G, there are four USB ports which complies with USB EHCI, Rev. 3.0. Refer to Appendix A.5 for pin assignments.

2.6 RTC Battery Specification

The UNO-2484G has an RTC Battery to ensure the setting in BIOS and system clock can be kept, even with power disconnected for a short time.

- **Type:** BR2032
- **Output Voltage:** 3 V_{DC}

2.7 Power Button/Power Management

Press the “PWR” button to power on or power off the UNO-2484G(ATX type). The UNO-2484G supports the ACPI (Advanced Configuration and Power Interface). Besides power on/off, it supports multiple suspend modes, such as Power on Suspend (S1), Suspend to RAM (S3), Suspend to Disk (S4). In S3 and S4 suspend mode, the power consumption can be less than 2W which meets Energy Star requirements.

2.8 Reset Button

Press the “Reset” button to activate the hardware reset function.

2.9 PCI Express Mini Card Socket

The UNO-2484G supports one full size socket for PCI Express mini cards. The (MINI1) interface is mainly targeted at supporting iDoor technology/modules for diverse applications such as isolated COM port, Profibus, WLAN GPRS, 3G, mRAM and iDoor Module. Users can install the card easily using the optional kit.

Note! *An additional SIM card slot is disabled. Please note you still require 3G Mini-PCIe built-in SIM card slot module installed to be able to use 3G functions. (models produced before June 2015)*



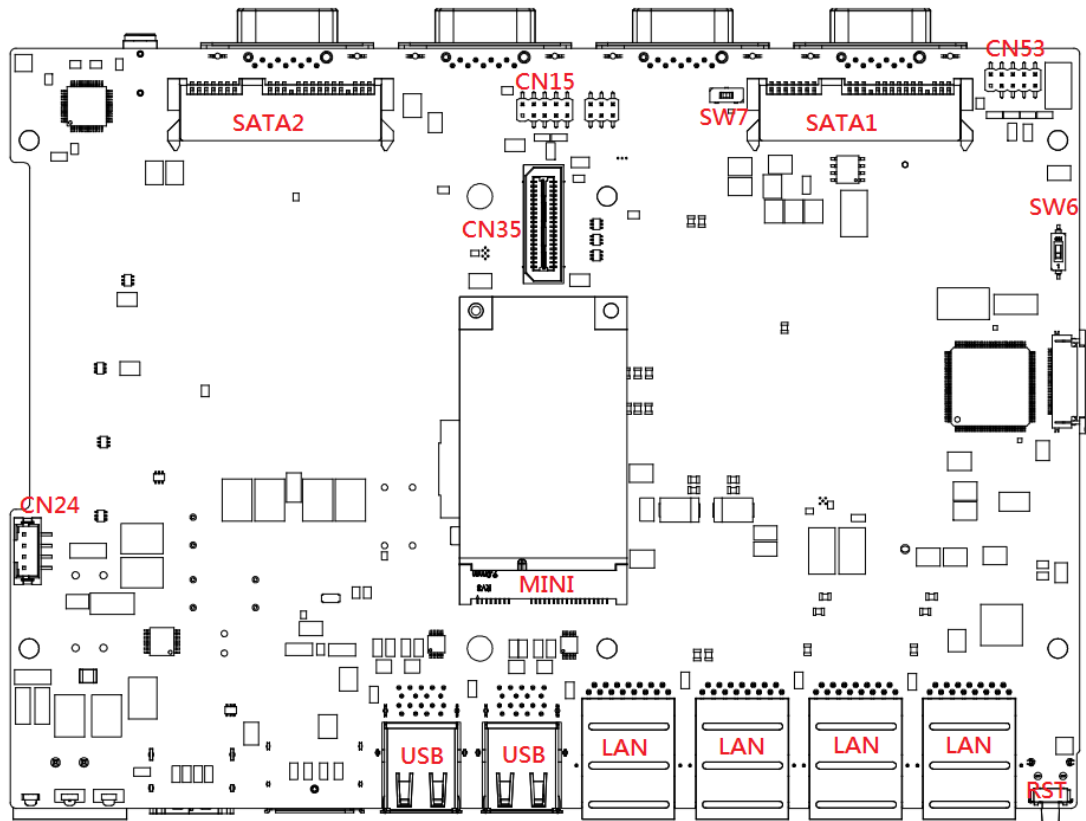

The UNO-2484G supports one socket full size PCI Express mini cards.

Chapter 3

Initial Setup

This chapter introduces how to initialize the UNO-2484G.

Sections include:

- Inserting an M.2
- Chassis Grounding
- Connecting Power
- Installing a Wireless LAN Card and Antenna

3.1 Chassis Grounding

UNO-2484G provides good EMI protection and a stable grounding base. There is an easy-to-connect chassis grounding point to use.

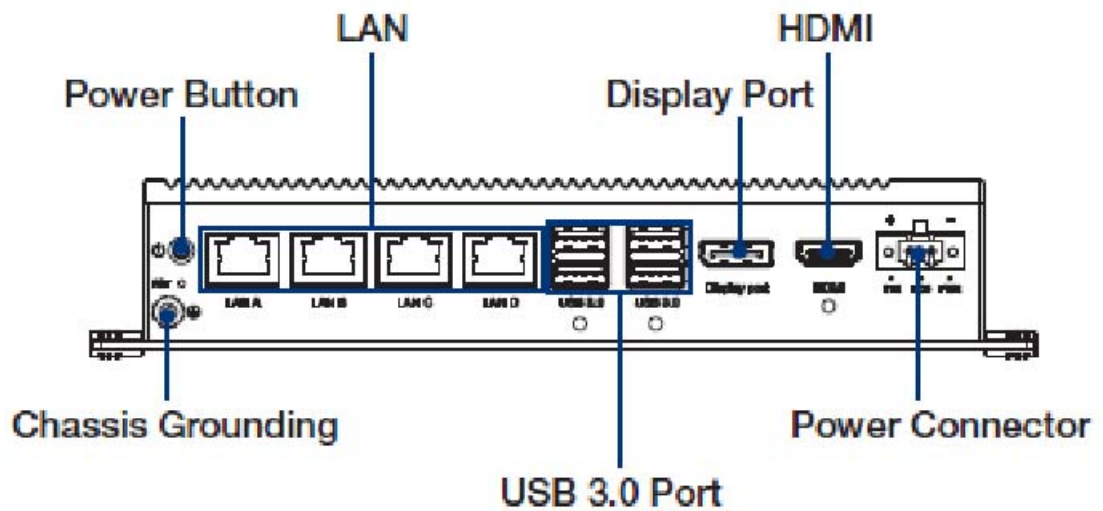

Figure 3.1 Chassis Grounding Connection

3.2 Connecting Power

This product is intended to be supplied by a listed power adapter or DC power source, rated at 10 - 36Vdc, 8A and Tma 60 degree C, if you need further assistance, please contact Advantech for further information.

Appendix **A**

System Settings/Pin
Assignments

A.1 CN10 Internal GPIO Pin Header

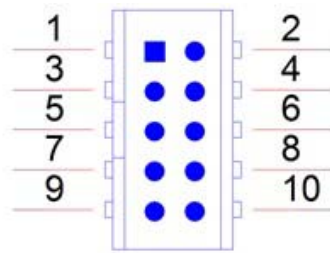

Table A.1: CN10 Internal GPIO Pin Header

Pin	Signal
1	+5V
2	GPIO0
3	GPIO1
4	GPIO2
5	GPIO3
6	GPIO4
7	GPIO5
8	GPIO6
9	GPIO7
10	GND

A.2 Board Connectors and Jumpers

There are several connectors and jumpers on the UNO-2484G board. The following sections tell you how to configure the UNO-2484G hardware setting.

Figure A.1 shows the locations of UNO-2484G's connectors and jumpers.

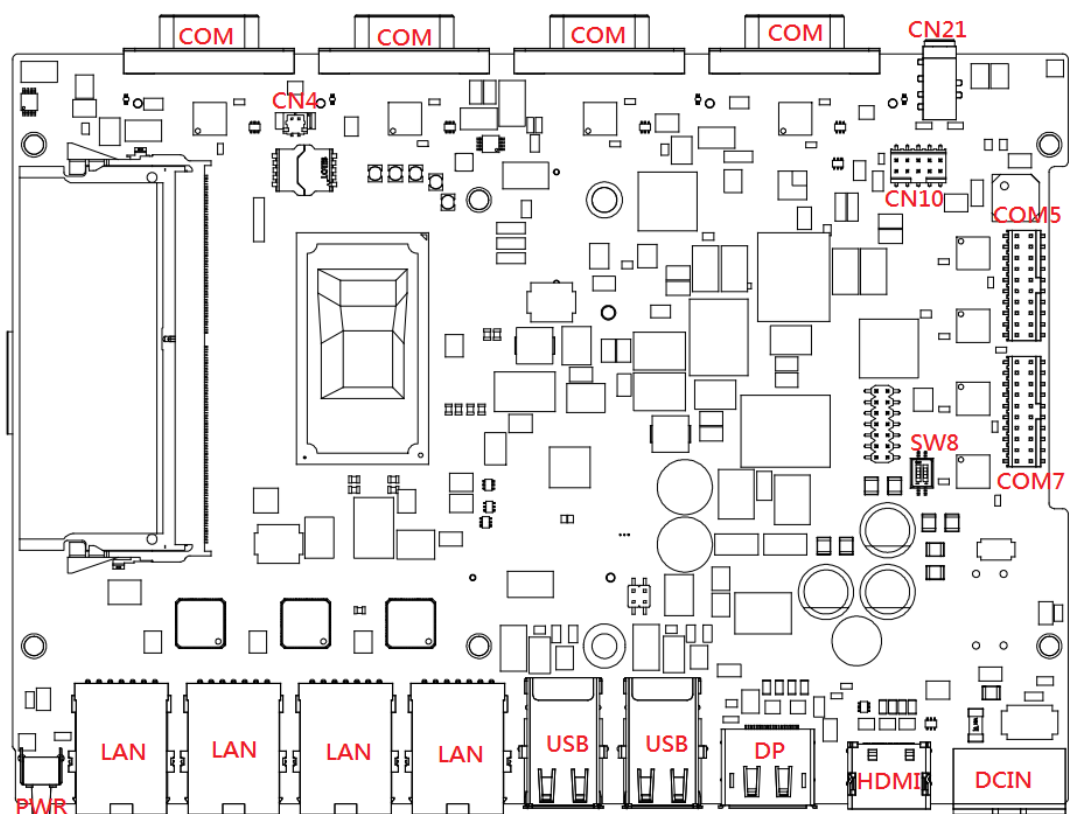

Figure A.1 Connector & Jumper Locations (front)

Table A.2: Connectors and Jumpers

Label	Function
DCIN	Power in connector
HDMI	HDMI connector
DP	DisplayPort connector
USB	USB3.0 connector
LAN	RJ45 connector
PWR	Power button
RST	Reset button
COM	COM port connector
COM5/COM7	Internal COM port pin header
MINI	PCI Express mini card socket / mSATA
SATA1/SATA2	SATA connector
CN4	RTC battery connector
CN10	Internal GPIO pin header
CN15/CN53	Internal USB2.0 pin header
CN21	Audio Line-out
CN24	Internal power connector, voltage is same as DCIN
CN35	Board to board connector
SW6	AT/ATX mode switch. ON -> ATX mode, OFF -> AT mode.
SW7	Clear COMS switch. Pin1 -> normal, Pin3 -> Clear
SW8	Disable internal COM5~8, Pin (1-2) -> enable, Pin (3-4) -> disable

A.3 Power Connector (PWR)

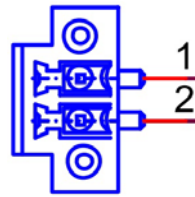

Table A.3: Power connector pin assignments

Pin	Signal	Description
1	Power IN V+	10 ~ 36V _{DC}
2	Power IN V- (GND)	

A.4 DP Connector

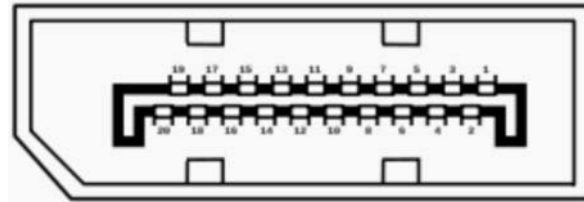

Table A.4: DisplayPort adaptor cable pin assignment

Pin	Signal Name
1	ML_Lane 0 (p)
2	GND
3	ML_Lane 0 (n)
4	ML_Lane 1 (p)
5	GND
6	ML_Lane 1 (n)
7	ML_Lane 2 (p)
8	GND
9	ML_Lane2 (2)
10	ML_Lane 3 (p)
11	GND
12	ML_Lane 3 (n)
13	CONFIG1
14	CONFIG2
15	AUX CH (p)
16	GND
17	AUX CH (n)
18	Hot Plug
19	Return
20	DP_PWR

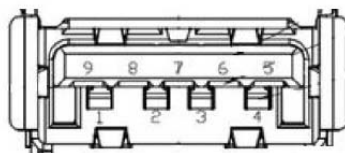

Table A.5: USB 3.0 Connector Pin Assignments

Pin	Signal Name	Description
1	VBUS	Power
2	D-	USB2.0 differential pair
3	D+	
4	GND	Ground for power return
5	StdA_SSRX-	SuperSpeed receiver differential pair
6	StdA_SSRX+	
7	GND_DRIAN	Ground for signal return
8	StdA_SSTX-	SuperSpeed transmitter differential pair
9	StdA_SSTX+	

A.5 HDMI Display Connector

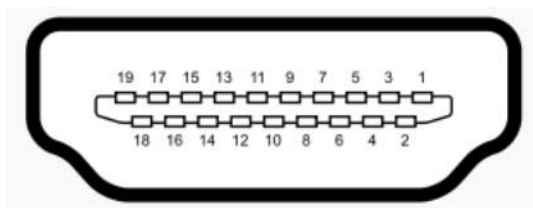

Table A.6: HDMI Display Connector

Pin	Signal	Pin	Signal
1	TMDS Data2+	2	TMDS Data2 Shield
3	TMDS Data2-	4	TMDS Data1+
5	TMDS Data1 Shield	6	TMDS Data1-
7	TMDS Data0+	8	TMDS Data0 Shield
9	TMDS Data0-	10	TMDS Clock+
11	TMDS Clock Shield	12	TMDS Clock-
13	CEC	14	Reserved
15	SCL	16	SDA
17	DDC/CEC/HEC Ground	18	+5 V Power (max 50 mA)
19	Hot Plug Detect		

A.6 COM1/COM2/COM3/COM4 RS232/422/485 connector

Pin	RS232	RS422	RS485
1	DCD	TX-	D-

2	RX	TX+	D+
3	TX	RX+	
4	DTR	RX-	
5	GND	GND	GND
6	DSR		
7	RTS		
8	CTS		
9	RI		

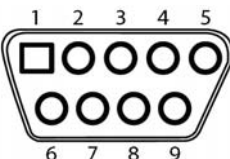

A.7 Mini PCIE slot (MINIPCI-E)

Supports PCI1.1, PCI1.2 Power Definition

Pin	Signal	Description	Pin	Signal	Description
52	+3.3Vaux / +3.3V	PCI1.1 was +3.3V, PCI1.2 was +3.3Vaux	51	Reserved	NC
50	GND		49	Reserved	NC
48	+1.5V		47	Reserved	NC
46	NC	NC	45	Reserved	NC
44	NC	NC	43	PIN43_MPCIE_PWRSEL	The pin to select the Pin 2, 52 power output for +3.3Vaux or +3.3V (PCI1.1 was Reserved and PIC1.2 was GND)
42	NC	NC	41	+3.3Vaux	
40	GND		39	+3.3Vaux	
38	USB_D+	USB serial data interface compliant to the USB 2.0 specification	37	GND	
36	USB_D-		35	GND	
34	GND		33	PETp0	PCI Express differential transmit pair
32	SMB_DATA	SMBus data signal compliant to the SMBus 2.0 specification	31	PETn0	
30	SMB_CLK		29	GND	
28	+1.5V		27	GND	
26	GND		25	PERp0	PCI Express differential receive pair
24	+3.3Vaux		23	PERn0	
22	PERST#	Functional reset to the card	21	GND	
20	W_DISABLE#	Active low signal. This signal is used by the system to disable radio operation on add-in cards that implement radio frequency applications. When implemented, this signal requires a pull-up resistor on the card.	19	Reserved	NC
18	GND		17	Reserved	NC
	Key	Key		Key	Key
16	NC	NC	15	GND	
14	NC	NC	13	REFCLK+	
12	NC	NC	11	REFCLK-	
10	NC	NC	9	GND	
8	NC	NC	7	CLKREQ#	Reference clock request signal
6	1.5V		5	NC	NC
4	GND		3	NC	NC
2	+3.3Vaux / +3.3V	PCI1.1 was +3.3V , PCI1.2 was +3.3Vaux	1	WAKE#	Open Drain active Low signal. This signal is used to request that the system return from a sleep/suspended state to service a function initiated wake event.

* +3.3Vaux was suspend Power , power out to device +3.3V/1.1A

* +3.3V was core power

* +1.5V was core power, power out to device +1.5V/0.5A

A.8 LAN RJ45 connector

RJ45 Pin	Signal	Description
1	MDI0+	<ul style="list-style-type: none"> In BASE-T: Media Dependent Interface[0]: 1000BASE-T: In MDI configuration, MDI[0]+/- corresponds to BI_DA+/- and in MDI-X configuration MDI[0]+/- corresponds to BI_DB+/-.
2	MDI0-	<ul style="list-style-type: none"> 10BASE-T and 100BASE-TX: In MDI configuration, MDI[0]+/- is used for the transmit pair and in MDIX configuration MDI[0]+/- is used for the receive pair.
3	MDI1+	<ul style="list-style-type: none"> In BASE-T: Media Dependent Interface[1]: 1000BASE-T: In MDI configuration, MDI[1]+/- corresponds to BI_DB+ and in MDI-X configuration MDI[1]+/- corresponds to BI_DA+/-.
6	MDI1-	<ul style="list-style-type: none"> 10BASE-T and 100BASE-TX: In MDI configuration, MDI[1]+/- is used for the receive pair and in MDI-X configuration MDI[1]+/- is used for the transmit pair.
4	MDI2+	<ul style="list-style-type: none"> In BASE-T: Media Dependent Interface[3:2]: 1000BASE-T: In MDI and in MDI-X configuration, MDI[2]+/- corresponds to BI_DC+/- and MDI[3]+/- corresponds to BI_DD+/-. 100BASE-TX: Unused. 10BASE-T: Unused.
5	MDI2-	
7	MDI3+	
8	MDI3-	

Left LED		Right LED	
10Link	100Link	1000 Link	Active
Off	Orange	Green	Green

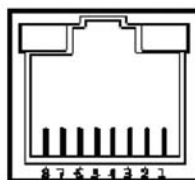

A.9 CN15/CN53 Internal USB2.0 Pin Header

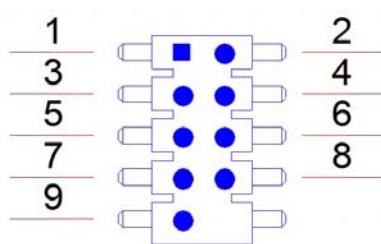
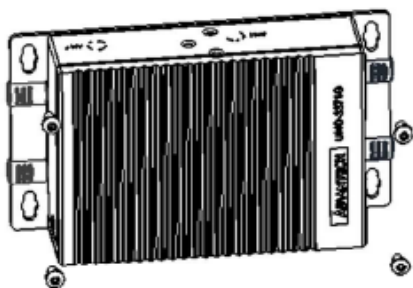

Table A.7: CN15/CN53 Internal USB2.0 Pin Header

Pin	Signal
1	+5V
2	+5V
3	USB1-
4	USB2-
5	USB1+
6	USB2+
7	GND
8	GND
9	NC

A.10 Screw Type and Quantity for Mounting Module



Screw: M3*P0.5*6L
Quantity: 4 pcs

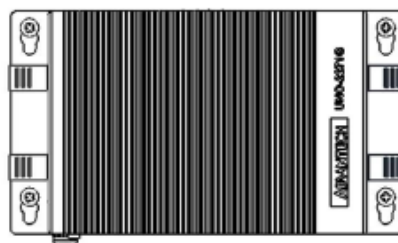

Head diameter: 5 ~ 5.3 mm

www.advantech.com

Please verify specifications before quoting. This guide is intended for reference purposes only.

All product specifications are subject to change without notice.

No part of this publication may be reproduced in any form or by any means, electronic, photocopying, recording or otherwise, without prior written permission of the publisher.

All brand and product names are trademarks or registered trademarks of their respective companies.

© Advantech Co., Ltd. 2017