



User Manual

MIC-770

Embedded IPC

Trusted ePlatform Services

ADVANTECH

Copyright

The documentation and the software included with this product are copyrighted 2019 by Advantech Co., Ltd. All rights are reserved. Advantech Co., Ltd. reserves the right to make improvements in the products described in this manual at any time without notice.

No part of this manual may be reproduced, copied, translated or transmitted in any form or by any means without the prior written permission of Advantech Co., Ltd. Information provided in this manual is intended to be accurate and reliable. However, Advantech Co., Ltd. assumes no responsibility for its use, nor for any infringements of the rights of third parties, which may result from its use.

Acknowledgements

Award is a trademark of Award Software International, Inc.

Intel® and Pentium® are trademarks of Intel Corporation.

Microsoft Windows® is a registered trademark of Microsoft Corp.

Cooper is a trademark of Eaton Corporation.

Infineon is a trademark of Infineon Technologies.

TI is a trademark of Texas Instruments.

Asmedia is a trademark of Asmedia Technology INC.

Exar is a trademark of Exar Corporation.

INTERSIL is a trademark of Intersil Corporation.

Nuvoton is a trademark of Nuvoton Technology Corporation.

All other product names or trademarks are properties of their respective owners.

For more information about this and other Advantech products, please visit our website at:

<http://www.advantech.com/>

<http://www.advantech.com/ePlatform/>

For technical support and service, please visit our support website at:

<http://support.advantech.com.tw/support/>

Product Warranty (2 years)

Advantech warrants to you, the original purchaser, that each of its products will be free from defects in materials and workmanship for two years from the date of purchase.

This warranty does not apply to any products which have been repaired or altered by persons other than repair personnel authorized by Advantech, or which have been subject to misuse, abuse, accident or improper installation. Advantech assumes no liability under the terms of this warranty as a consequence of such events.

Because of Advantech's high quality-control standards and rigorous testing, most of our customers never need to use our repair service. If an Advantech product is defective, it will be repaired or replaced at no charge during the warranty period. For out-of-warranty repairs, you will be billed according to the cost of replacement materials, service time and freight. Please consult your dealer for more details.

If you think you have a defective product, follow these steps:

1. Collect all the information about the problem encountered. (For example, CPU speed, Advantech products used, other hardware and software used, etc.) Note anything abnormal and list any onscreen messages you get when the problem occurs.
2. Call your dealer and describe the problem. Please have your manual, product, and any helpful information readily available.
3. If your product is diagnosed as defective, obtain an RMA (return merchandise authorization) number from your dealer. This allows us to process your return more quickly.
4. Carefully pack the defective product, a fully-completed Repair and Replacement Order Card and a photocopy proof of purchase date (such as your sales receipt) in a shippable container. A product returned without proof of the purchase date is not eligible for warranty service.
5. Write the RMA number visibly on the outside of the package and ship it prepaid to your dealer.

Declaration of Conformity

FCC Class A

Note: This equipment has been tested and found to comply with the limits for a Class A digital device, pursuant to part 15 of the FCC Rules. These limits are designed to provide reasonable protection against harmful interference when the equipment is operated in a commercial environment. This equipment generates, uses, and can radiate radio frequency energy and, if not installed and used in accordance with the instruction manual, may cause harmful interference to radio communications. Operation of this equipment in a residential area is likely to cause harmful interference in which case the user will be required to correct the interference at his own expense.

Technical Support and Assistance

1. Visit the Advantech web site at www.advantech.com/support where you can find the latest information about the product.
2. Contact your distributor, sales representative, or Advantech's customer service center for technical support if you need additional assistance. Please have the following information ready before you call:
 - Product name and serial number
 - Description of your peripheral attachments
 - Description of your software (operating system, version, application software, etc.)
 - A complete description of the problem
 - The exact wording of any error messages

Warnings, Cautions and Notes

Warning! *Warnings indicate conditions in which there is a chance of personal injury!*



Caution! *Cautions are included to help you avoid damaging hardware or losing data. e.g.:*



There is a danger of a new battery exploding if it is incorrectly installed. Do not attempt to recharge, force open, or heat the battery. Replace the battery only with the same or equivalent type recommended by the manufacturer. Discard used batteries according to the manufacturer's instructions.

Note! *Notes provide optional additional information.*



Safety Instructions

1. Please read these safety instructions carefully.
2. Please keep this User's Manual for later reference.
3. Please disconnect this equipment from AC outlet before cleaning. Use a damp cloth. Don't use liquid or sprayed detergent for cleaning. Use moist sheet or cloth for cleaning.
4. For pluggable equipment, the socket-outlet shall near the equipment and shall be easily accessible.
5. Please keep this equipment from humidity.
6. Lay this equipment on a reliable surface when installing. A drop or fall could cause injury.
7. The openings on the enclosure are for air convection hence protecting the equipment from overheating. **DO NOT COVER THE OPENINGS.**
8. Make sure the voltage of the power source when connecting the equipment to the power outlet.
9. Place the power cord such a way that people cannot step on it. Do not place anything over the power cord.
10. All cautions and warnings on the equipment should be noted.
11. If the equipment is not used for long time, disconnect the equipment from mains to avoid being damaged by transient over-voltage.
12. Never pour any liquid into ventilation openings; this could cause fire or electrical shock.
13. Never open the equipment. For safety reasons, only qualified service personnel should open the equipment.
14. If one of the following situations arises, get the equipment checked by service personnel:
 - The power cord or plug is damaged.
 - Liquid has penetrated into the equipment.
 - The equipment has been exposed to moisture.
 - The equipment does not work well, or you cannot get it to work according to the user's manual.
 - The equipment has been dropped and damaged.
 - The equipment has obvious signs of breakage.
15. **DO NOT LEAVE THIS EQUIPMENT IN AN ENVIRONMENT WHERE THE STORAGE TEMPERATURE MAY GO BELOW -40° C (-40° F) OR ABOVE 85° C (185° F). THIS COULD DAMAGE THE EQUIPMENT. THE EQUIPMENT SHOULD BE IN A CONTROLLED ENVIRONMENT.**
16. **CAUTION: DANGER OF EXPLOSION IF BATTERY IS INCORRECTLY REPLACED. REPLACE ONLY WITH THE SAME OR EQUIVALENT TYPE RECOMMENDED BY THE MANUFACTURER, DISCARD USED BATTERIES ACCORDING TO THE MANUFACTURER'S INSTRUCTIONS.**
17. The sound pressure level at the operator's position according to IEC 704-1:1982 is no more than 70 dB (A).
18. **RESTRICTED ACCESS AREA:** The equipment should only be installed in a Restricted Access Area.

DISCLAIMER: This set of instructions is given according to IEC 704-1. Advantech disclaims all responsibility for the accuracy of any statements contained herein.

Packing List

Before installation, please ensure the following items have been shipped:

■ MIC-770 bare-bone system x1	
■ MIC-770 Startup manual x1	P/N: 2041077000
■ 4-pin Phoenix connector	P/N: 1652003234
■ Mounting bracket x2	P/N: 1960070543T001
■ SATA cable x1	P/N: 1700013095
■ SATA Power cable x1	P/N:1700024372-01
■ Thermal pad for memory	P/N: 1990019498N000
■ Thermal grease for CPU	P/N: 2170000093-01

Ordering Information

Module Number	PCH	VGA	HDMI	2.5" HDD/SSD	USB3.1/3.0/2.0	GbE	COM	PCIE/PCI Exp	Power
MIC-770Q-00A1	Q370	1	1	1	2/6/0	2	2, up to 6 via cable	i-module (Optional)	DC9~36V
MIC-770H-00A1	H310	1	1	1	0/4/4	2	2, up to 6 via cable	i-module (Optional)	DC9~36V

Optional i-Module

Module Number	Description
4-slot expansion module	
MIC-75M13-00A1E	1 x PCIe x16+3xPCI slot i-module
MIC-75M40-00A1E	1 x PCIe x8+3xPCIe x4 slot i-module
2-slot expansion module	
MIC-75M20-00B1	1 x PCIe x16+1xPCIe x4 slot i-module
MIC-75M20-01A1E	2 x PCIe x8 slot i-module
MIC-75M11-00A1E	1 x PCIe x16+1xPCI slot i-module
MIC-75G20-00A1	1 x PCIe x16 (Doible Deck)+1xPCIe x4+2x2.5" hot-swap HDD/SSD GPU slot i-module
2-slot expansion and storage module	
MIC-75S20-00A1E	1 x PCIe x16+ 1 x PCIe x4 slot+ 2x2.5" swappable HDD/SSD
1-slot expansion module	
MIC-75M10-00A1	1 x PCIe x16 slot

Optional Accessories

Part Number	Description
96PSA-A220W24P4-1	ADP A/D 100-240V 220W 24V
96PSA-A150W19P4-1	ADP A/D 100-240V 150W 19V
1702002600	Power Cord 3P UL/CSA(USA) 125V 10A 1.83M 180D
1700022940-01	Power cord PSE 7A 125V 3P 3m DAC-ST01
1702002605	Power cord 2P FRANCE 10A/16A 220V 1.83M 90D
AIIS-DIO32-00A1E	AIIS-32bit GPIO module
PCA-TPM-00B1E	TPM 2.0 module
98R1750000E	Secondary DVI module accessory kit
98R1750010E	HDMI/Remote switch module accessory kit
98R1750030E	HDMI accessory kit
98R1750040E	Remote switch accessory kit
98R1790040E	Dual LAN module (MIC-770Q-00A1 only)
i-Door Module (MOS series module)	Supports i-Door module (MOS series), except PoE Please refer to Advantech website below or search "iDoor Module Mini PCIe Expansion Kit". http://www.advantech.com.tw/products/idoor-module-mini-pcie-expansion-kit/sub_bc858a7f-a52b-441b-a59c-f511289f98bc
i-Door Module (PCM series module)	Supports i-Door module (PCM series) except PoE Please refer to Advantech website below: http://www.advantech.com/products/idoor-technology-mini-pcieexpansion-kit/sub_efdb96af-a8f7-4cde-9592-dbf5c9794d16 Note: A bracket is required to fix PCM series i-door module. Please refer to P/N: 1960065854N001 i Door_bracket

i-module Optional Accessories

Part Number	Description
98R1751300E	1x8cm FAN module (for MIC-75M13/75M40/75S20)
98R1752000E	2x4cm FAN module (for MIC-75M20/MIC-75M11)

Contents

Chapter 1	General Introduction	1
1.1	Introduction	2
1.2	Product Features.....	2
1.2.1	General	2
1.2.2	Display	2
1.2.3	Ethernet	3
1.3	Chipset.....	3
1.3.1	Functional specification.....	3
1.4	Mechanical Specifications.....	4
1.4.1	Dimensions	4
	Figure 1.1 MIC-770 Mechanical Dimension Drawing	4
1.4.2	Weight.....	4
1.5	Power Requirements.....	5
1.5.1	System power	5
1.5.2	RTC battery.....	5
1.6	Environment Specification.....	5
1.6.1	Operating temperature.....	5
1.6.2	System safety certification test temperature	5
1.6.3	Relative humidity.....	5
1.6.4	Storage temperature	5
1.6.5	Vibration during operation.....	5
1.6.6	Shock during operation	5
1.6.7	Safety.....	5
1.6.8	EMC	5
Chapter 2	H/W Installation.....	7
2.1	Introduction	8
2.2	Jumper & Slide Switch	8
2.2.1	Jumper description.....	8
2.2.2	Jumper list.....	9
	Table 2.1: Jumper List.....	9
2.3	Connectors.....	10
2.3.1	MIC-770 External I/O Connectors	10
	Figure 2.1 MIC-770 Front View.....	10
	Table 2.2: COM Connector Pin Assignments	11
	Figure 2.2 Ethernet Connector	11
	Table 2.3: Ethernet Connector Pin Assignments.....	11
	Figure 2.3 Audio Connector	12
	Table 2.4: Audio Connector Pin Assignments	12
	Figure 2.4 USB 3.0 Connector.....	12
	Table 2.5: USB 3.0 Connector Pin Assignment.....	12
	Figure 2.5 VGA Connector	13
	Table 2.6: VGA Connector Pin Assignments.....	13
	Figure 2.6 HDMI receptacle connector	13
	Table 2.7: HDMI Connector pin assignments	13
	Figure 2.7 4-pin header	14
	Table 2.8: Pin Assignments for Power Connector Pin Header..	14
	Figure 2.8 Power Button	14
	Figure 2.9 LED Indicators	14
2.4	Installation	15
2.4.1	HDD installation	15
2.4.2	Memory Installation	17
2.4.3	m-SATA/Mini-PCIe Installation	17

2.4.4	Internal USB 2.0 Installation (Q SKU only)	18
2.4.5	COM 3/4/5/6 Ports Installation	18
2.4.6	Expansion module Installation (Optional)	19
2.4.7	MIC-770 MB I/O connector	21

Chapter 3 BIOS Operation 23

3.1	Introduction	24
	Figure 3.1 Main setup screen	24
3.2	Entering BIOS Setup	25
3.2.1	Main Menu	26
	Figure 3.2 Main setup screen	26
3.2.2	Advanced BIOS Features Setup	27
	Figure 3.3 Advanced BIOS features setup screen	27
	Figure 3.4 Platform Misc Configuration	28
	Figure 3.5 CPU Configuration	29
	Figure 3.6 Power & Performance	30
	Figure 3.7 CPU Power Management Control	30
	Figure 3.8 PCH-FW Configuration	31
	Figure 3.9 AMT Configuration	32
	Figure 3.10 CIRA Configuration	32
	Figure 3.11 ASF Configuration	33
	Figure 3.12 Secure Erase Configuration	34
	Figure 3.13 OEM Flags Settings	34
	Figure 3.14 MEBx Resolution Settings	35
	Figure 3.15 TPM Settings	36
	Figure 3.16 ACPI Settings	37
	Figure 3.17 SMART Settings	38
	Figure 3.18 Super IO Configuration	39
	Figure 3.19 Serial Port 1 Configuration	39
	Figure 3.20 Serial Port 2 Configuration	40
	Figure 3.21 Serial Port 3 Configuration	40
	Figure 3.22 Serial Port 4 Configuration	41
	Figure 3.23 Serial Port 5 Configuration	41
	Figure 3.24 Serial Port 6 Configuration	42
	Figure 3.25 PC Health Status	43
	Figure 3.26 Fan Configuration	44
	Figure 3.27 S5 RTC Wake Settings	45
	Figure 3.28 Serial Port Console Redirection	46
	Figure 3.29 Intel TXT Information	47
	Figure 3.30 PCI Subsystem Settings	47
	Figure 3.31 CSM Configuration	48
	Figure 3.32 USB Configuration	49
	Figure 3.33 Network Stack	50
3.2.3	Chipset	50
	Figure 3.34 Chipset	50
	Figure 3.35 System Agent (SA) Configuration	51
	Figure 3.36 Graphics Configuration	52
	Figure 3.37 PEG Port Configuration	53
	Figure 3.38 PEG Port Feature Configuration	53
	Figure 3.39 Memory Configuration	54
	Figure 3.40 PCH-IO Configuration	55
	Figure 3.41 PCI Express Root Port Setting	56
	Figure 3.42 SATA Configuration	57
	Figure 3.43 USB Configuration	58
	Figure 3.44 HD Audio Configuration	59
	Figure 3.45 Security Configuration	60
3.2.4	Security	61
	Figure 3.46 Security	61

3.2.5	Boot.....	62
	Figure 3.47Boot	62
3.2.6	Save & Exit	63
	Figure 3.48Save & Exit.....	63

Chapter 4 Software Installation65

4.1	Before you begin	66
4.2	Introduction	66
4.3	Windows Driver Setup.....	66

Appendix A Programming the Watchdog Timer..67

A.1	Programming the Watchdog Timer	68
A.1.1	Watchdog Timer Overview.....	68
A.1.2	Programming the Watchdog Timer	68
	Table A.1: Watchdog Timer Registers	70
A.1.3	Example Program	71

Appendix B Programming the GPIO75

B.1	Supported GPIO Register	76
B.1.1	GPIO Registers.....	76
B.1.2	GPIO Example Program	77

Chapter 1

General Introduction

This chapter gives background information on MIC-770.

1.1 Introduction

MIC-770 is a compact, fanless system incorporating latest generation Intel® 14nm platform with new PCH Q370/H310 on a proprietary form factor M/B. MIC-770 system design concept focusses on an “expansion slot module”, so different applications can integrate the MIC-770 system to form a complete industrial computer.

The MIC-770 also can serve as an independent, fanless, Compact Embedded Box computer and accepts a wide range of DC power inputs. The rugged aluminum case not only provides a great thermal solution, but also resists high EMI/shock/vibration. MIC-770 is equipped with Intel® 8th Core i desktop CPU featuring 6 cores, making it highly suitable for embedded and industrial PC applications requiring high processor performance within limited spaces. It features powerful I/O interfaces, including Ethernet, USB 3.0, serial port, and two Mini PCIe.

1.2 Product Features

1.2.1 General

- **CPU:** Intel® 8th Gen Core™ i CPU socket (LGA1151)
- **PCH:** Intel® Q370/H310
- **System Memory:** Dual-channel DDR4 2133/2400/2666 MHz (without ECC), up to 32GB
- **Storage Devices:** Supports 1 drive bay space for SATA 2.5" HDD/SSD
- **mSATA:** Supports 1 x mSATA by mini-PCIe slot
- **Graphic:** VGA + HDMI
- **Ethernet Port:** 2 x RJ45
- **Watchdog Timer:** Single chip watchdog 255-level interval timer, setup by software
- **I/O Interface:** 2 x RS-232/422/485 supports auto flow control; 4 x RS-232 via optional cable
- **USB:**
 - Q370: 2 x USB3.1, 6 x USB3.0 and 1 x internal USB 2.0
 - H310: 4 x USB 3.0 and 4 x USB 2.0
- **Audio:** High Definition Audio (HD), Line-out, Mic-in
- **Expansion interface:**
 - Q370: 1 x mini PCIe (via USIM), 1x mini PCIe/mSATA
 - H310: 1 x mini PCIe (via USIM), 1x mSATA

1.2.2 Display

- **Chipset:**
 - Q370: Intel® HD Graphics 630, supports DirectX 12
 - H310: Intel® HD Graphics 610, supports DirectX 12
- **Graphics Video Max Memory:** 1.7 GB
- **Resolution:**
 - VGA: Supports up to 2048 x 1152 @ 60 Hz
 - HDMI: Supports up to 3840 x 2160 @ 30Hz

1.2.3 Ethernet

- **Chipset:**
 - Q370 LAN1: Intel® I219LM, LAN2: Intel® i210IT
 - H310 LAN1: Intel® I219V, LAN2: Intel® i210IT
- **Speed:** 10/100/1000 Mbps
- **Interface:** 2 x RJ45
- **Standard:** Compliant with IEEE 802.3, IEEE802.3u, IEEE 802.ab.

1.3 Chipset

1.3.1 Functional specification

1.3.1.1 Processor

Processor	Intel® 8th Gen Core™ i CPU socket (LGA1151)
------------------	---

1.3.1.2 Chipset

PCH	<ul style="list-style-type: none"> ■ Intel® Q370/H310 chipset
Memory	<ul style="list-style-type: none"> ■ Supports DDR4 2133/2400/2666MHz (without ECC) ■ SODIMM Socket: <ul style="list-style-type: none"> – 260-pin SODIMM socket*2 (up to 16 GB per socket)
Chipset integrated Intel HD Graphic	<ul style="list-style-type: none"> ■ Intel® HD Graphics 630/610 ■ Supports DirectX 12 ■ Supports OpenGL 4.4 ■ Supports Intel® Quick Sync Video ■ IO interface <ul style="list-style-type: none"> – VGA: Supports resolutions up to 2048 x 1152 @ 60 Hz (VGA connector: On-board D-SUB 15P) – HDMI: Supports resolution up to 3840×2160 @30Hz (HDMI Connector: On-board HDMI)
SATA Interface	<ul style="list-style-type: none"> ■ 3 x SATA3.0 (Q SKU), 1 x SATA3.0 (H SKU) ■ Legacy IED (Including IRQ)/Native AHCI appearance to OS ■ Partial/slumber power management modes with wake ■ Capable of 6Gbit/s transfer rate
USB Interface	<ul style="list-style-type: none"> ■ Q370: 2 x USB3.1, 6 x USB3.0 and 1 x internal USB 2.0 ■ H310: 4 x USB 3.0 and 4 x USB 2.0 ■ Supports high-speed, full-speed, and low-speed capable ■ Supports legacy keyboard/mouse software
Power Management	<ul style="list-style-type: none"> ■ Supports ACPI 5.0 ■ ACPI Power Management Logic supported ■ Power Connector: plug-in block 4Px1
BIOS	<ul style="list-style-type: none"> ■ AMI 256Mb Flash BIOS via SPI

1.3.1.3 Others

Serial ports	<p>Nuvoton NCT 6106D supported</p> <ul style="list-style-type: none">■ Up to 6 serial ports by Nuvoton NCT6106D supported■ High speed NS16C550A compatible UARTs with data rates to 1.5 Mbps■ Supports IRQ sharing among serial port■ COM1/2: Supports RS-232/422/485 and setting mode by BIOS and supports auto flow control■ COM 3~6: Support for RS-232, via optional cable <p>Serial ports connector: D-SUB CON.9P</p>
LAN	<p>Q370 LAN1: Intel® I219LM, LAN2: Intel® i210IT H310 LAN1: Intel® I219V, LAN2: Intel® i210IT</p> <ul style="list-style-type: none">■ Compliant with IEEE 802.3, IEEE 802.3u, IEEE 802.ab.■ Supports 10/100/1000 Mbps■ Supports Wake on LAN
Audio	<p>Audio Codec: Realtek ALC888:</p> <ul style="list-style-type: none">■ Compliant with HD Audio specifications■ Supports to 16/20/24-bit DAC and 16/20/24-bit ADC resolution■ Supports: Line-out, Mic-in■ DAC supports 16/20/24-bit PCM format, multiple stereo recording
Battery backup	<ul style="list-style-type: none">■ BR2032 3 V/190mAh

1.4 Mechanical Specifications

1.4.1 Dimensions

UNIT : mm

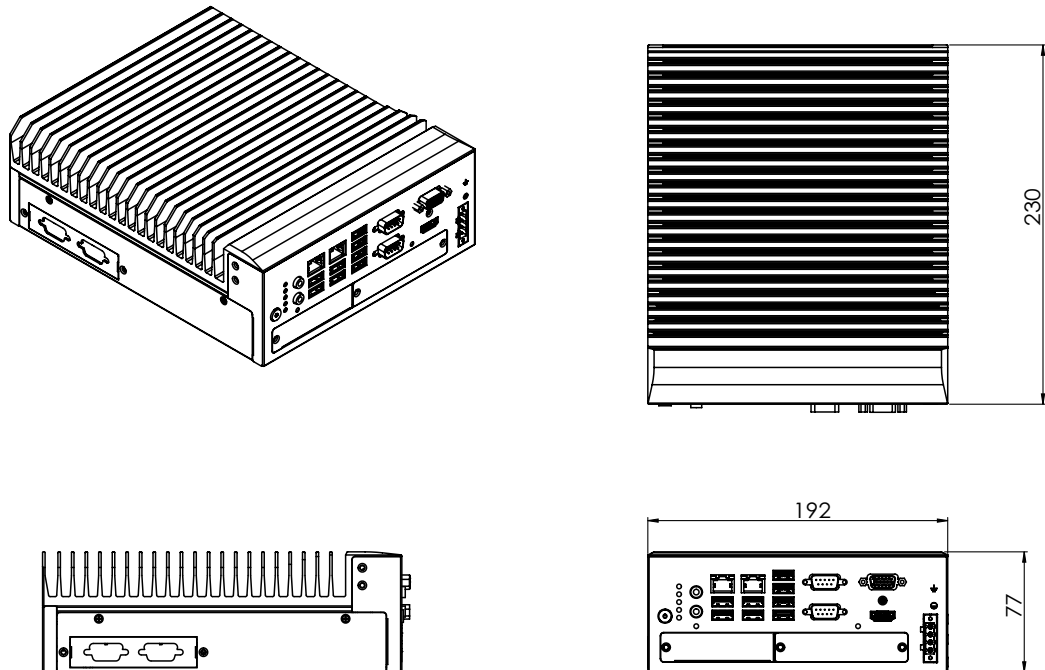

Figure 1.1 MIC-770 Mechanical Dimension Drawing

1.4.2 Weight

2.8kg (6.17lbs)

1.5 Power Requirements

1.5.1 System power

- Minimum power input: DC12V (-25%) -30V (+20%), Absolute Maximum Ratings Voltage is 9V - 36V

1.5.2 RTC battery

- BR2032 3 V/190 mAh

1.6 Environment Specification

1.6.1 Operating temperature

- -10 ~ 40°C (65W CPU) & -10 ~ 50°C(35W CPU) with 0.7m/sec air flow: with 1 x Industrial SSD without PC expansion boards

1.6.2 System safety certification test temperature

- 0 ~ 40°C with 2.5" HDD

1.6.3 Relative humidity

- 95% @ 40°C (non-condensing)

1.6.4 Storage temperature

- -40 ~ 85°C (-40 ~ 185°F)

1.6.5 Vibration during operation

- When system is equipped with SSD only: 3 Grms, IEC 60068-2-64, random, 5 ~ 500 Hz, 1 Oct/min., 1 hr/axis, x,y,z 3 axes.
- When system is equipped with 2.5-inch HDD: 1 Grms, IEC 60068-2-64, random, 5 ~ 500 Hz, 1 Oct/min., 1 hr/axis, x,y,z 3 axes.

1.6.6 Shock during operation

- When system is equipped with SSD only: 20 G, IEC 60068-2-27, half sine, 11 ms duration.

1.6.7 Safety

- UL/CB, CCC, BSMI

1.6.8 EMC

- CE, FCC, CCC, BSMI

Chapter 2

H/W Installation

This chapter introduces external IO and the installation of MIC-770 hardware.

2.1 Introduction

The following sections show the internal jumper settings and the external connectors and pin assignments.

2.2 Jumper & Slide Switch

2.2.1 Jumper description

You may configure the MIC-770 to match the needs of your application by setting jumpers. A jumper is a metal bridge used to close an electric circuit. It consists of two metal pins and a small metal clip (often protected by a plastic cover) that slides over the pins to connect them. To close a jumper, you connect the pins with the clip. To open a jumper, you remove the clip. Sometimes a jumper will have three pins, labeled 1, 2 and 3. In this case you would connect either pins 1 and 2, or 2 and 3.

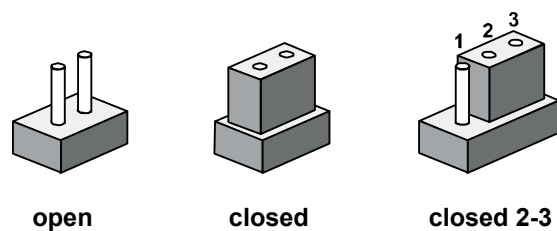

The jumper settings are schematically depicted in this manual as follows.

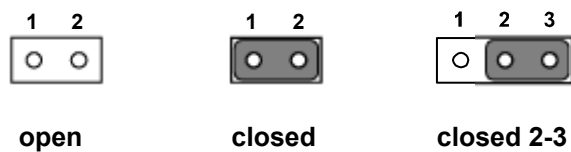

A pair of needle-nose pliers may be helpful when working with jumpers. If you have any doubts about the best hardware configuration for your application, contact your local distributor or sales representative before you make any changes. Generally, you simply need a standard cable to make most connections.

2.2.2 Jumper list

Table 2.1: Jumper List

Label	Function
JCMOS1	Clear CMOS
PSON1	System AT/ATX mode option
JME1	ME jumper mode option
JWDT1_JOBS1	Watch-Dog mode option

2.2.2.1 Clear CMOS

MIC-770 single board computer contains a jumper that can erase CMOS data and reset the system BIOS information. Normally this jumper should be set with pins 1-2 closed. If you want to reset the CMOS data, set CMOS1 to 2-3 closed for just a few seconds, and then move the jumper back to 1-2 closed. This procedure will reset the CMOS to its default setting.

CMOS1	Clear CMOS
Footprint	3x1 Pin
Setting	Function
(1-2)	Normal (default)
(2-3)	Clear CMOS

2.2.2.2 System AT/ATX mode function option

MIC-770 supports AT or ATX mode and default is ATX module. If you want to change to AT mode you can find AT/ATX mode jumper on the motherboard.

PSON1	System AT/ATX mode option
FootPrint	3x1 Pin
Setting	Function
(1-2)	AT module
(2-3)	ATX module

2.2.2.3 System ME mode function option

MIC-770 supports ME Enable & Disable and the default is "Disable". If you want to change the ME mode you can set ME mode jumper on the motherboard.

JME1	System ME mode option
FootPrint	3x1 Pin
Setting	Function
(1-2)	ME Enable
(2-3)	ME Disable (Default)

2.2.2.4 System Watch-Dog mode function option

MIC-770 single board computer contains a jumper that can set Watchdog mode.

JWDT1_JOBS1	Watch-Dog mode function option
FootPrint	5x1 pin
Setting	Function
(2-3)	Watchdog
(4-5)	ERR_BEEP

2.2.2.5 USB Standby power & VGA always on setting (eFuse)

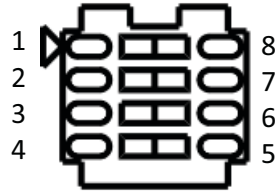

eFuse (SW5)

Switch	State	Setting
SW5-1	1 (default)	USB3C1 not provide standby charging
	8	USB3C1 provide standby charging
SW5-2	2 (default)	USB3C2 not provide standby charging
	7	USB3C2 provide standby charging
SW5-3	3 (default)	USB3C3 not provide standby charging
	6	USB3C3 provide standby charging
SW5-4	4 (default)	VGA is always on
	5	VGA will be ON by cable detected

2.3 Connectors

2.3.1 MIC-770 External I/O Connectors

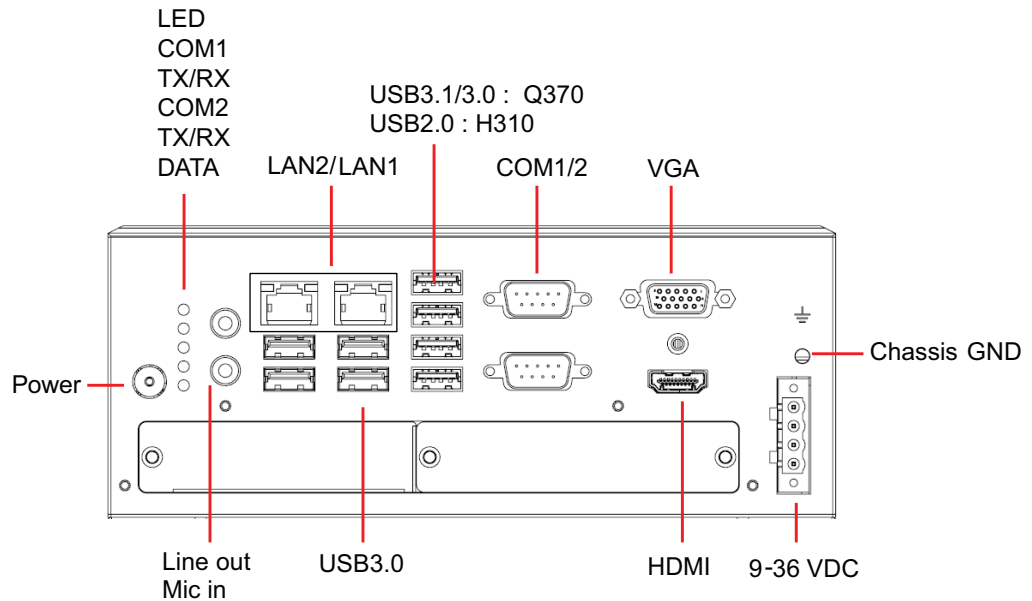

Figure 2.1 MIC-770 Front View

2.3.1.1 COM connector

MIC-770 provides four 9-pin D-sub connectors, two of which offer RS-232/422/485 and the other two offer RS-232 serial communication interface ports. Default setting is RS-232, but this can be modified by BIOS setting. You can find detailed setting methods in Chapter 3.

Table 2.2: COM Connector Pin Assignments

	RS-232	RS-422	RS-485
Pin	Signal Name	Signal Name	Signal Name
1	DCD	Tx-	DATA-
2	RxD	Tx+	DATA+
3	TxD	Rx+	NC
4	DTR	Rx-	NC
5	GND	GND	GND
6	DSR	NC	NC
7	RTS	NC	NC
8	CTS	NC	NC
9	RI	NC	NC

Note! NC represents "No Connection".



2.3.1.2 Ethernet connector (LAN)

MIC-770 is equipped with two Ethernet controllers that are fully compliant with IEEE 802.3u 10/100/1000 Mbps CSMA/CD standards. LAN1 is equipped with Intel i219 and LAN2 is equipped with Intel i210. The Ethernet port provides a standard RJ45 jack connector with LED indicators on the front side to show its Active/Link status and Speed status.

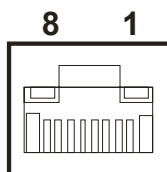

Figure 2.2 Ethernet Connector

Table 2.3: Ethernet Connector Pin Assignments

Pin	10/100/1000BaseT Signal Name
1	TX+
2	TX-
3	RX+
4	MDI2+
5	MDI2-
6	RX-
7	MDI3+
8	MDI3-

2.3.1.3 Audio connector

MIC-770 has two stereo audio ports with phone jack connectors, one Line_Out, one Mic_In. The audio chip is controlled by ACL892, and it's compliant with AZALIA standard.



Figure 2.3 Audio Connector

Table 2.4: Audio Connector Pin Assignments

Pin	Audio Signal Name
1	Line_Out
2	Mic_In

2.3.1.4 USB 3.0 connector

MIC-770 provides USB3.1/3.0 interface connectors, which give complete Plug & Play and hot swapping for up to 127 external devices. The USB interface complies with USB XHCI, Rev. 3.0. Please refer to the table below for pin assignments.

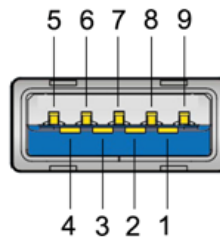

Figure 2.4 USB 3.0 Connector

Table 2.5: USB 3.0 Connector Pin Assignment

Pin 1	+5V
Pin 2	USB Data -
Pin 3	USB Data +
Pin 4	GND
Pin 5	SSRX-
Pin 6	SSRX+
Pin 7	GND
Pin 8	SSTX-
Pin 9	SSTX+

2.3.1.5 VGA Connector

The MIC-770 provides a high resolution VGA interface with a 15-pin D-sub connector to support a VGA CRT monitor. It supports display resolution of up to 2048 x 1152 @ 60 Hz.

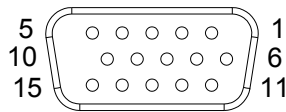

Figure 2.5 VGA Connector

Table 2.6: VGA Connector Pin Assignments

Pin	Signal Name	Pin	Signal Name
1	Red	2	Green
3	Blue	4	NC
5	GND	6	GND
7	GND	8	GND
9	+5V	10	GND
11	NC	12	DDC_DAT
13	H-SYNC	14	V-SYNC
15	DDC_CLK		

2.3.1.6 HDMI Connector

An integrated, 19-pin receptacle connector HDMI Type A Interface is provided. The HDMI link supports resolutions up to 2560 x 1600 @ 60Hz; 3840 x 2160 @ 30Hz.

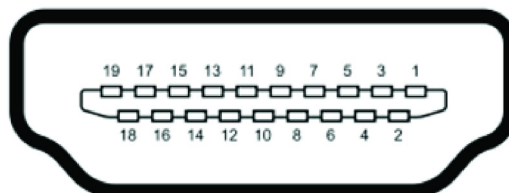

Figure 2.6 HDMI receptacle connector

Table 2.7: HDMI Connector pin assignments

Pin	Signal Name	Pin	Signal Name
1	TMDS Data 2+	2	TMDS Data 2 shield
3	TMDS Data 2-	4	TMDS Data 1+
5	TMDS Data 1 shield	6	TMDS Data 1-
7	TMDS Data 0+	8	TMDS Data 0 shield
9	TMDS Data 0-	10	TMDS clock+
11	TMDS clock shield	12	TMDS clock-
13	CEC	14	Reserved
15	SCL	16	SDA
17	DDC/CEC Ground	18	+5V
19	Hot Plug Detect		

2.3.1.7 Power Input Connector

MIC-770 comes with a four-pin header as default that carries 9VDC - 36VDC external power input.

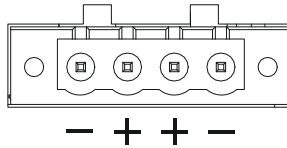

Figure 2.7 4-pin header

Table 2.8: Pin Assignments for Power Connector Pin Header

Pin	Signal Name
1	GND
2	+9 V _{DC} ~ 36 V _{DC}
3	+9 V _{DC} ~ 36 V _{DC}

2.3.1.8 Power ON/OFF button

MIC-770 comes with a Power On/Off button with LED indicators on the front side to show its On status (Green LED) and Off/Suspend status (RED LED), that supports dual function of Soft Power-On/Off (instant off or delay 4 seconds), and suspend.



Figure 2.8 Power Button

2.3.1.9 LED Indicators

MIC-770 provides COM1 & COM2 TX/RX LED for data transmission status monitoring.

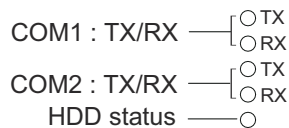
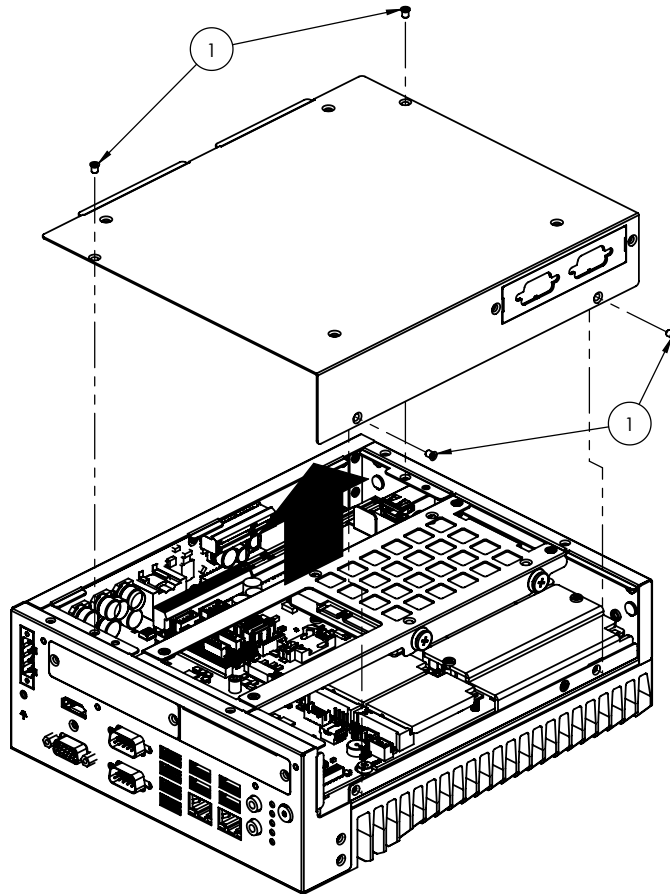

Figure 2.9 LED Indicators

2.4 Installation

2.4.1 HDD installation

1. Undo 4 screws and remove the bottom cover
2. Undo 4 screws to remove the HDD tray.



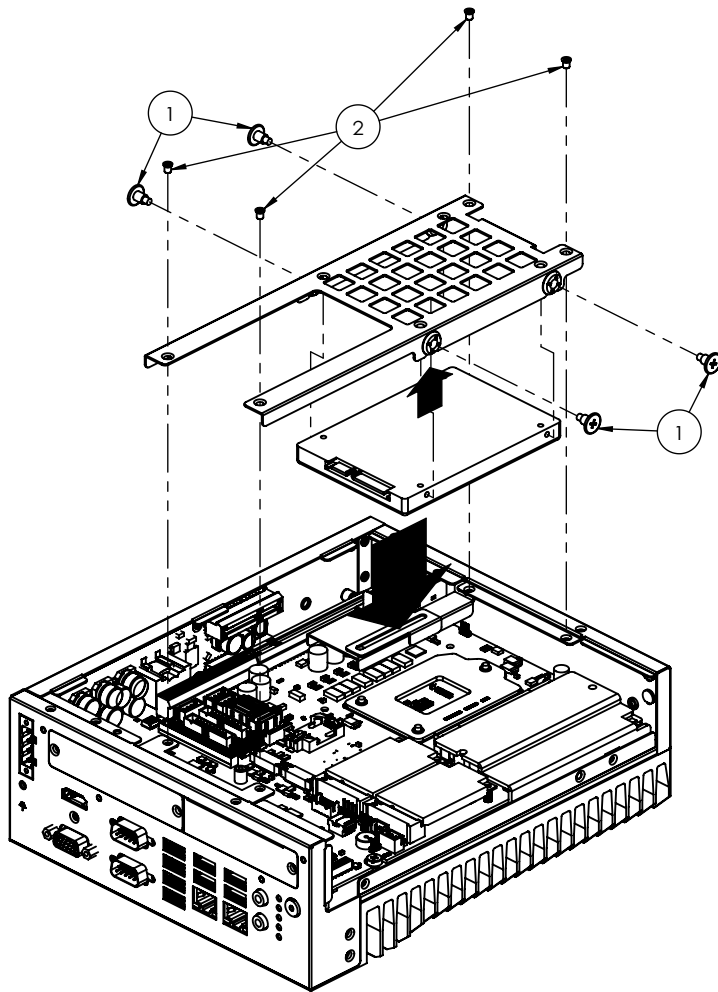

3. Secure the HDD with 4 x HDD screws (P/N:1930002235).
4. Assemble SATA cable/power cable and replace HDD tray; secure with 4 screws.
5. Replace bottom cover.

Note! Please refer to *i-module Manual* for *i-module* assembly.



2.4.2 Memory Installation

1. Undo the 4 screws to remove the bottom cover.
2. Undo 4 screws to remove the HDD tray.

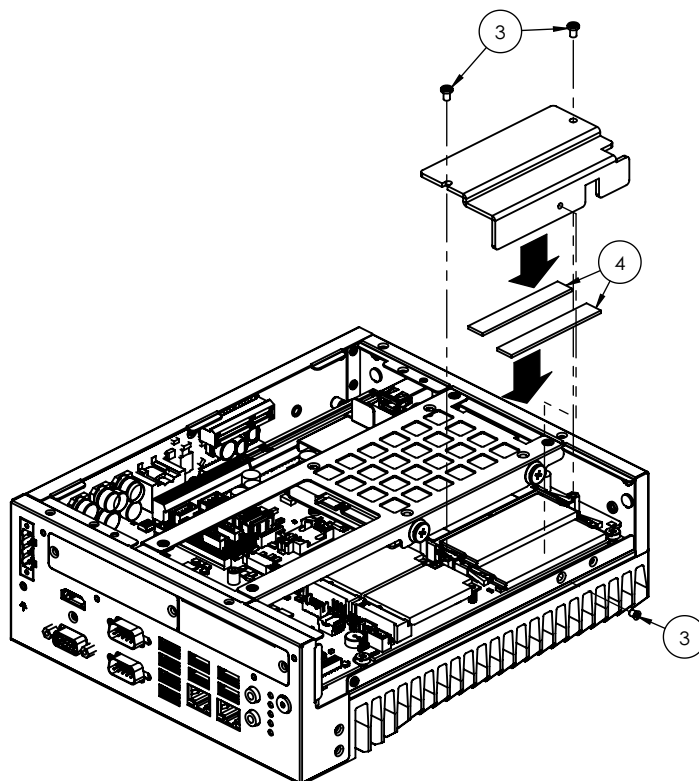

3. Undo 3 screws to remove the memory thermal cover.
4. Affix thermal pad (P/N: 1990019498N000) on memory, and reassemble memory.

Note! Thermal pad and memory thermal cover must be completely covered and secured.



2.4.3 m-SATA/Mini-PCle Installation

- Q370: 1x mini PCIe (via USIM), 1x mini PCIe/mSATA
 - H310: 1x mini PCIe (via USIM), 1x mSATA
1. Undo 4 screws and remove the bottom cover.
 2. Install the module in Mini PCIe socket 1, or m-SATA in Mini PCIe socket 2 and secure with screws.
 3. Replace bottom cover and secure with screws.

2.4.4 Internal USB 2.0 Installation (Q SKU only)

1. Undo 4 screws and remove the bottom cover.
2. Loosen the screws and adjust bracket size in accordance with the USB dongle size.
3. Replace the bottom cover and secure with screws.

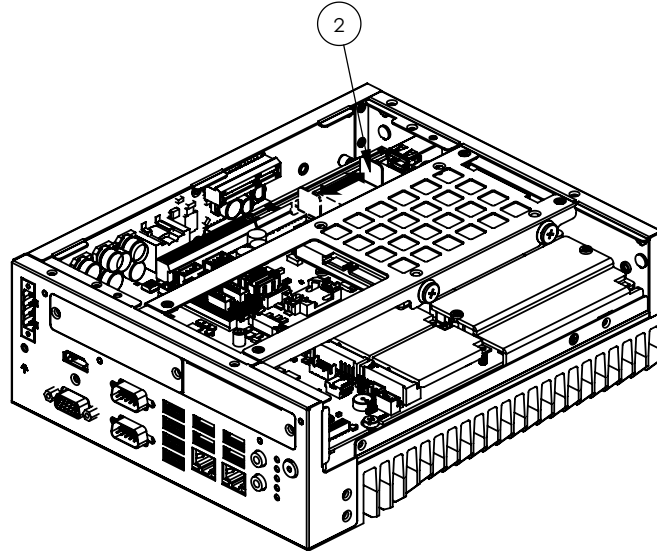

2.4.5 COM 3/4/5/6 Ports Installation

MIC-770 has support two standard RS-232/422/485 serial ports. If more serial ports are needed, MIC-770 can expand up to four serial ports by cable (RS-232 only). There is one DB9 cable in the accessory box.

1. Undo 4 screws and remove the bottom cover.
2. Replace baffle plate for COM 3/4 and COM5/6.
3. Remove HDD tray.
4. Assemble DP9 connector in baffle, and install cable at COM3/4 and COM5/6 connector.
5. Secure COM module in system and replace HDD tray/bottom cover.

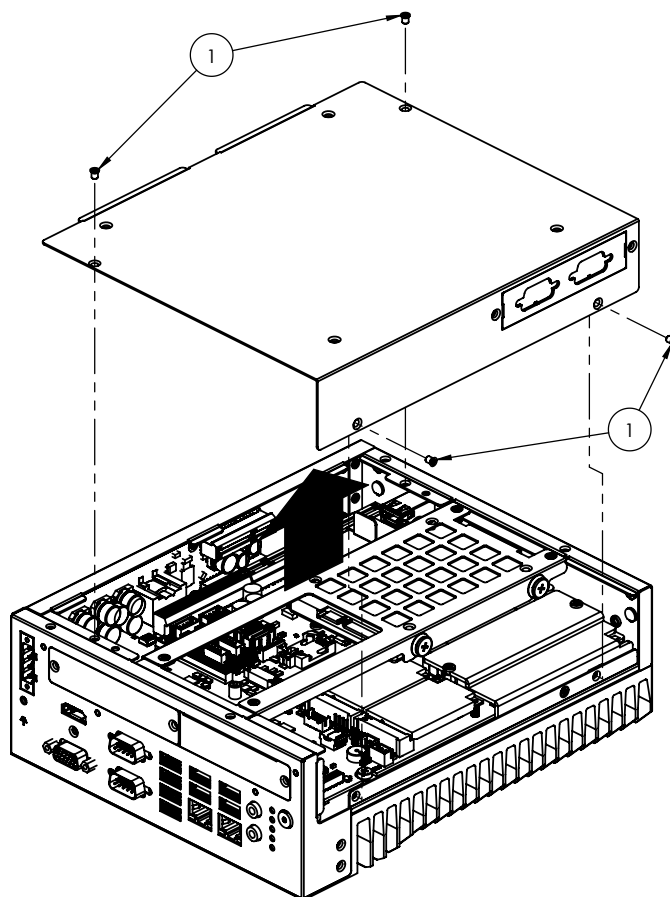

2.4.6 Expansion module Installation (Optional)

MIC-770 supports below optional modules for different applications.

A: Expansion module:

1. 32-bit GPIO module, P/N: AIIS-DIO32-00A1E
2. Secondary DVI module, P/N: 98R1750000E
3. HDMI/Remote power module, P/N: 98R1750010E
4. HDMI module, P/N: 98R1750030E
5. Remote power module: 98R1750040E
6. Dual LAN module, P/N: 98R1790040E (MIC-770Q only)

B: Bracket for expansion module

1. Undo the 4 screws and remove the bottom cover.
2. Undo HDD tray & expansion module baffle.

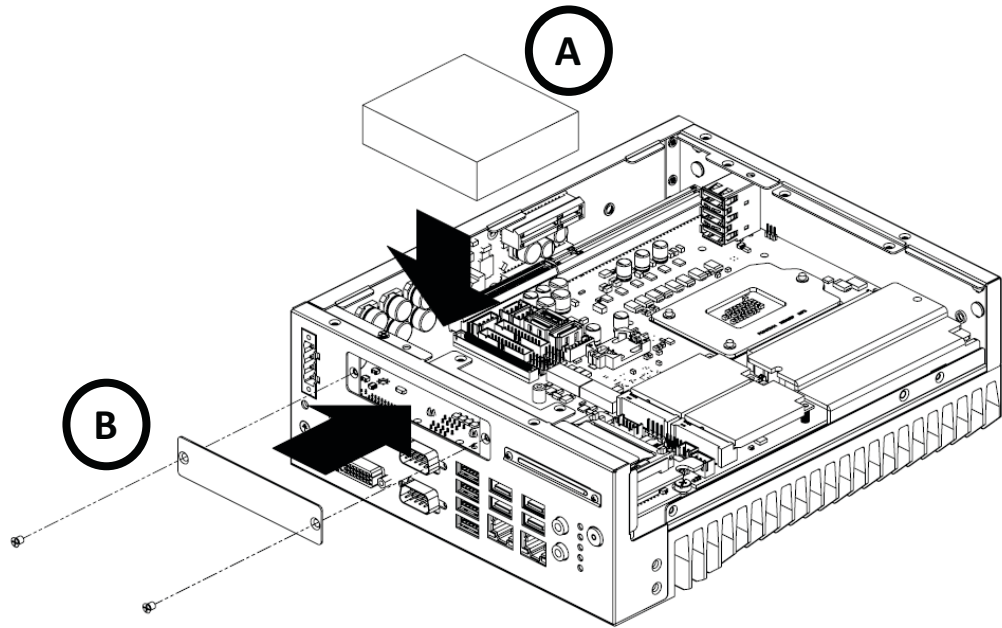

3. Remove COM cable and undo baffle cover.
4. Assemble module on M/B (Note: Optional expansion modules need to connect with a cable. (Please refer to MB internal I/O connector specification at IO connector page for GPIO connector.)
5. Assemble module baffle with screws.
6. Replace bottom cover and secure with screws.

2.4.7 MIC-770 MB I/O connector

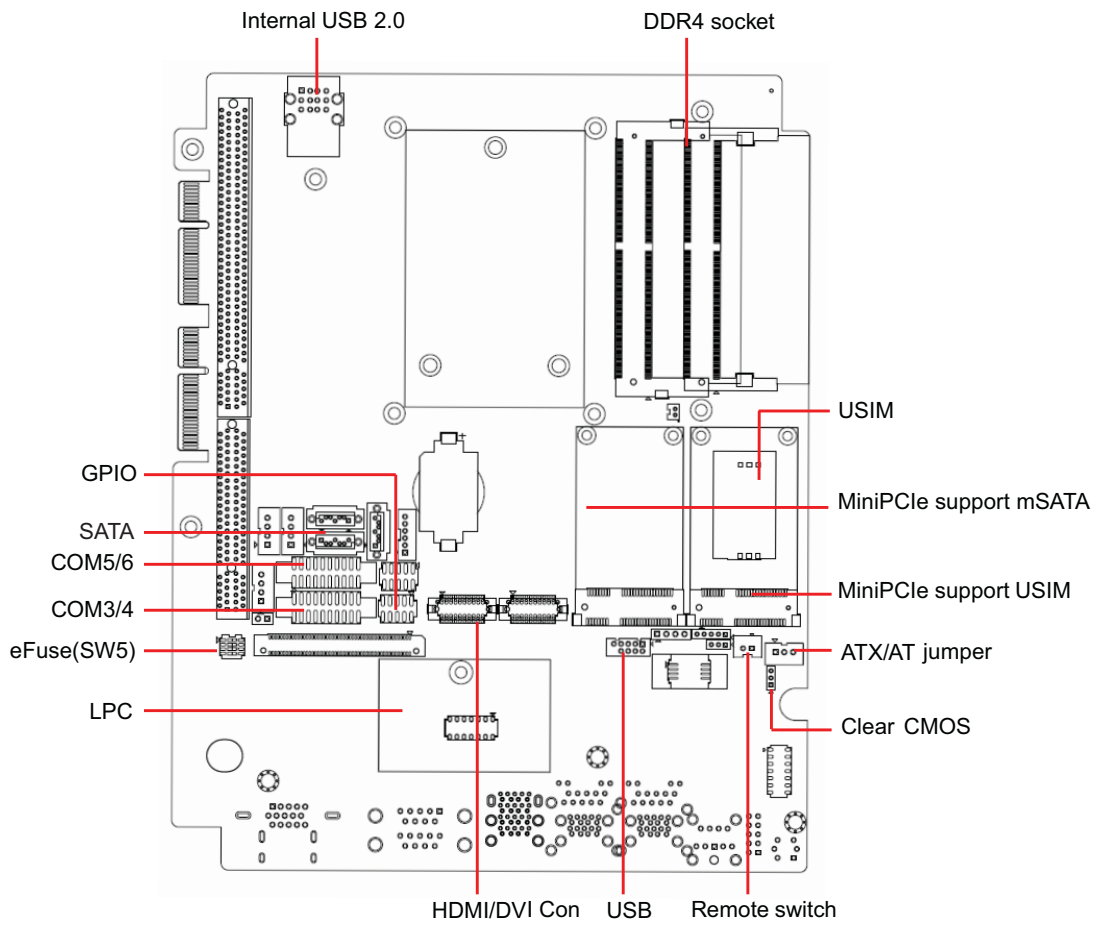

Chapter 3

BIOS Operation

3.1 Introduction

With the AMI BIOS Setup Utility, you can modify BIOS settings and control the specific features of your computer. The Setup Utility uses a number of menus for making changes and turning the specific features on or off. This chapter describes the basic navigation of the MIC-770 setup screens.

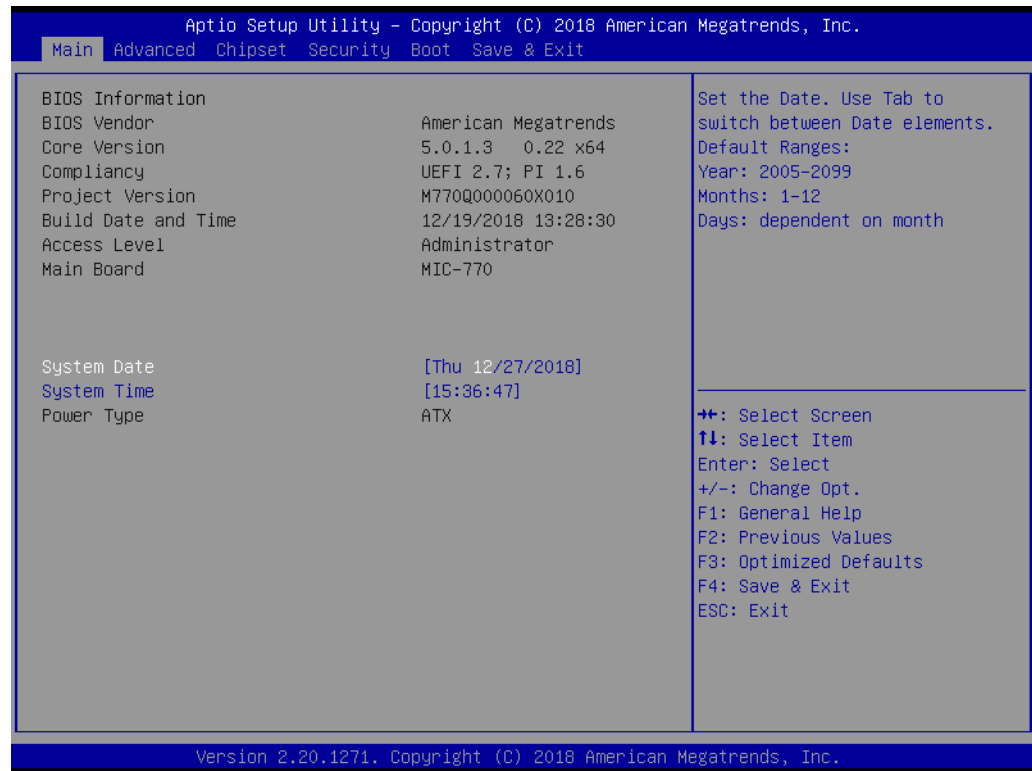

Figure 3.1 Main setup screen

AMI's BIOS ROM has a built-in Setup program that allows users to modify the basic system configuration. This information is stored in the NVRAM area so it retains the setup information when the power is turned off.

3.2 Entering BIOS Setup

Press to enter AMI BIOS Setup Utility, the Main Menu will appear on the screen. Use arrow keys to select among the items and press <Enter> to accept or enter the sub-menu.

The Main BIOS setup screen has two main frames. The left frame displays all the options that can be configured. Grayed-out options cannot be configured; options in blue can be. The right frame displays the key legend.

The key legend above is an area reserved for a text message. When an option is selected in the left frame, it is highlighted in white. Often a text message will accompany it.



3.2.1 Main Menu

When users first enter the BIOS Setup Utility, they enter the Main setup screen. Users can always return to the Main setup screen by selecting the Main tab. There are two Main Setup options described in this section. The Main BIOS Setup screen is shown below.



Figure 3.2 Main setup screen

■ System time / System date

Use this option to change the system time and date. Highlight System Time or System Date using the <Arrow> keys. Enter new values through the keyboard. Press the <Tab> key or the <Arrow> keys to move between fields. The date must be entered in MM/DD/YY format. The time must be entered in HH:MM:SS format.

3.2.2 Advanced BIOS Features Setup

Select the Advanced tab from the MIC-770 setup screen to enter the Advanced BIOS setup screen. You can select any of the items in the left frame of the screen, such as CPU configuration, to go to the sub menu for that item. You can display an Advanced BIOS Setup option by highlighting it using the <Arrow> keys. All Advanced BIOS Setup options are described in this section. The Advanced BIOS Setup screens are shown below. The sub menus are described on the following pages.

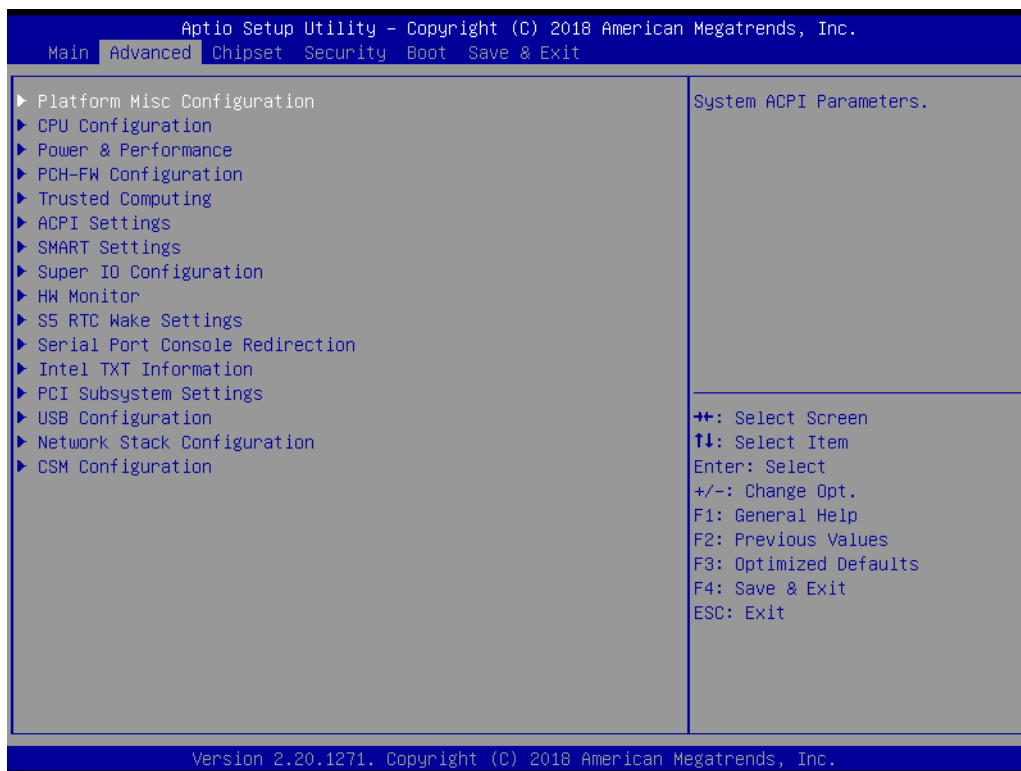

Figure 3.3 Advanced BIOS features setup screen

3.2.2.1 Platform Misc Configuration

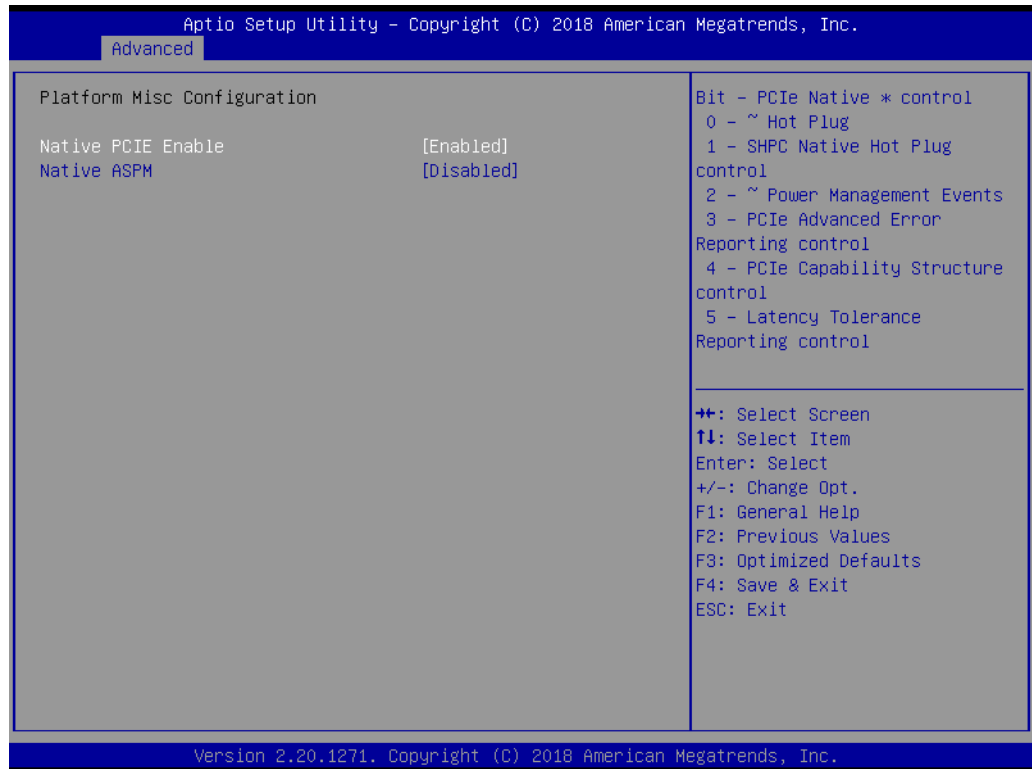

Figure 3.4 Platform Misc Configuration

- **Platform Misc Configuration**
 - **Native PCIE Enable**

PCI Express Native Support Enable/Disable. This is only available in Vista.
 - **Native ASPM**

On enable, Vista will control the ASPM support for the device. If disabled, the BIOS will.

3.2.2.2 CPU Configuration



Figure 3.5 CPU Configuration

- **Hardware Prefetcher**
Hardware Prefetcher is a technique that fetches instructions and/or data from memory into the CPU cache memory well before the CPU needs it to improve the load-to-use latency. You may choose to Enable or Disable it.
- **Adjacent Cache Line Prefetch**
The Adjacent Cache-Line Prefetch mechanism, like automatic hardware prefetch, operates without programmer intervention. When it is enabled through the BIOS, two 64-byte cache lines are fetched into a 128-byte sector, regardless of whether the additional cache line has been requested or not. You may choose to Enable or Disable it.
- **Intel Virtualization Technology**
This feature is used to Enable or Disable Intel Virtualization Technology (IVT) extension. It allows multiple operating systems to run simultaneously on the same system by creating virtual machines, each running its own x86 operating system.
- **Active Processor Core**
Use this item to select the number of processor cores you want to activate when you are using a dual or quad core processor.
- **AES**
Enable or Disable CPA advanced encryption standard instruction.
- **Intel Trusted Execution Technology**
"Enable or Disable" utilization of additional hardware capabilities provided by Intel Trusted Execution Technology. Changes require a full power cycle to take effect.
- **Rest AUX Content**
Reset TPM AUX content. TXT may not be functional after AUX content gets reset.

3.2.2.3 Power & Performance

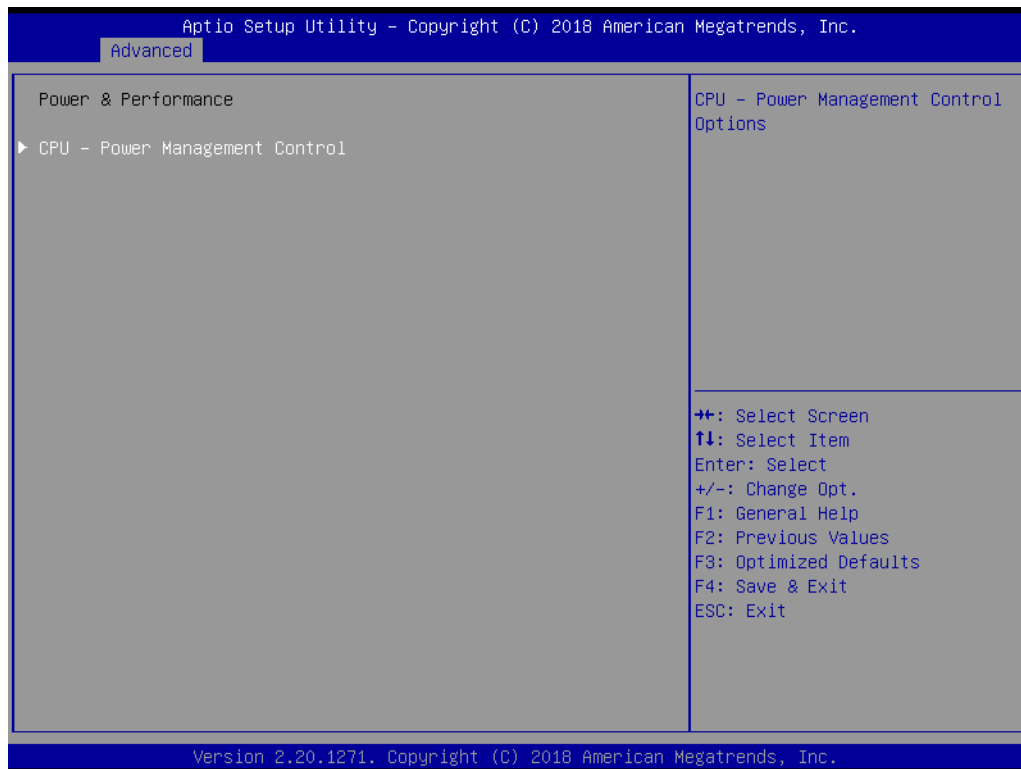

Figure 3.6 Power & Performance

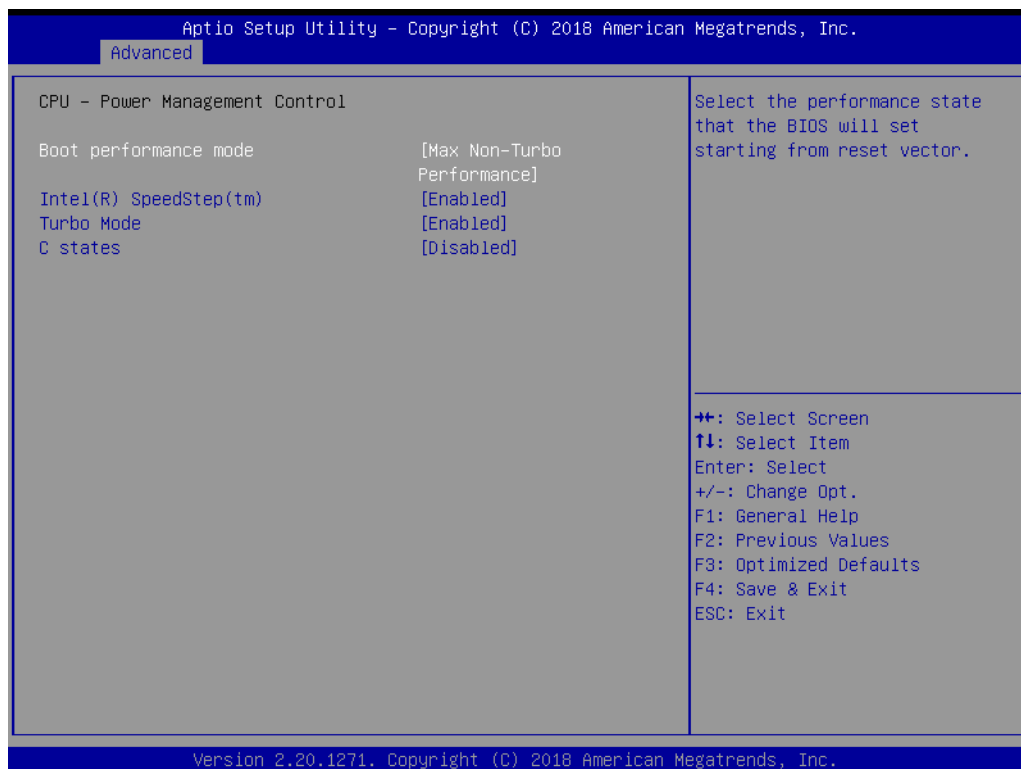

Figure 3.7 CPU Power Management Control

- **Boot Performance**
Select the performance state that the BIOS will set before OS handoff.
- **Intel(R) Speedstep(tm)**
Allows more than two frequency ranges to be supported.

- **Turbo Mode**
Turbo mode.
- **C states**
Intel C states setting for power saving.

3.2.2.4 PCH-FW Configuration

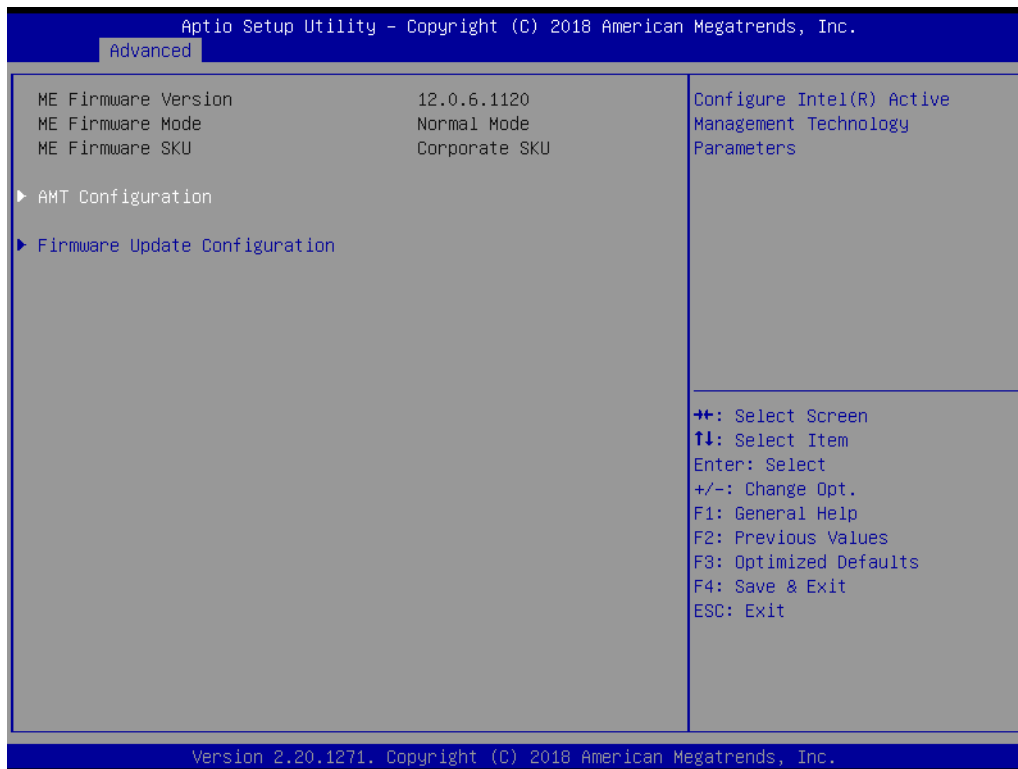

Figure 3.8 PCH-FW Configuration

- **PCH-FW Version**
PCH-FW page shows Intel ME FW information.

■ AMT Configuration

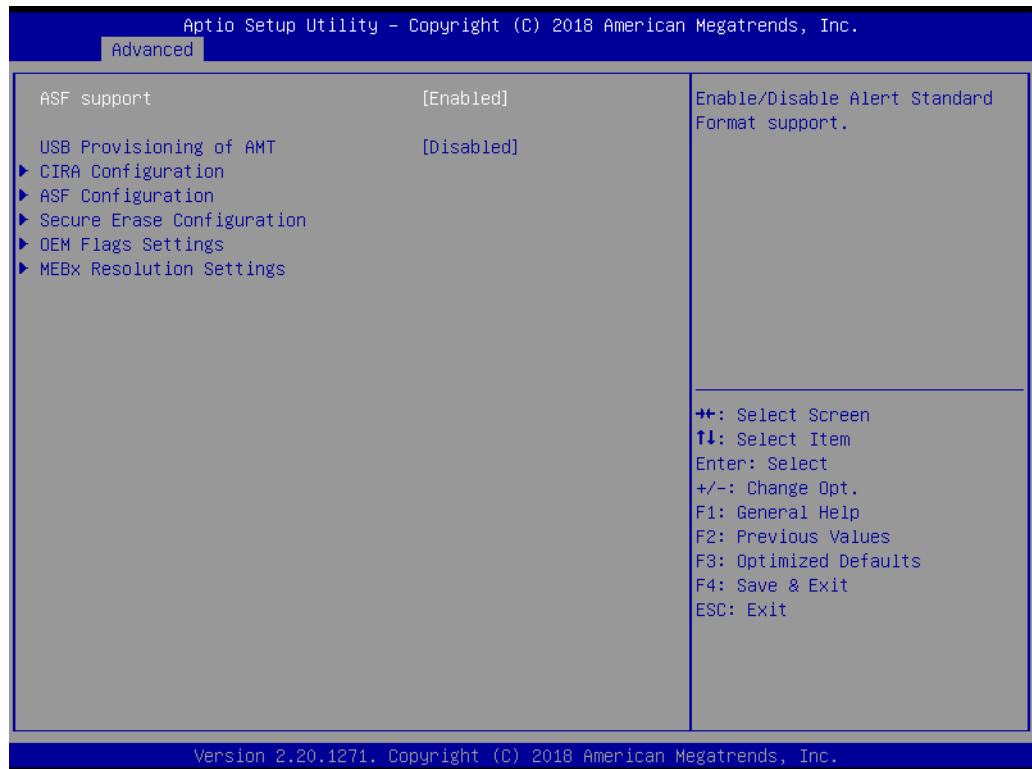

Figure 3.9 AMT Configuration

■ CIRA Configuration

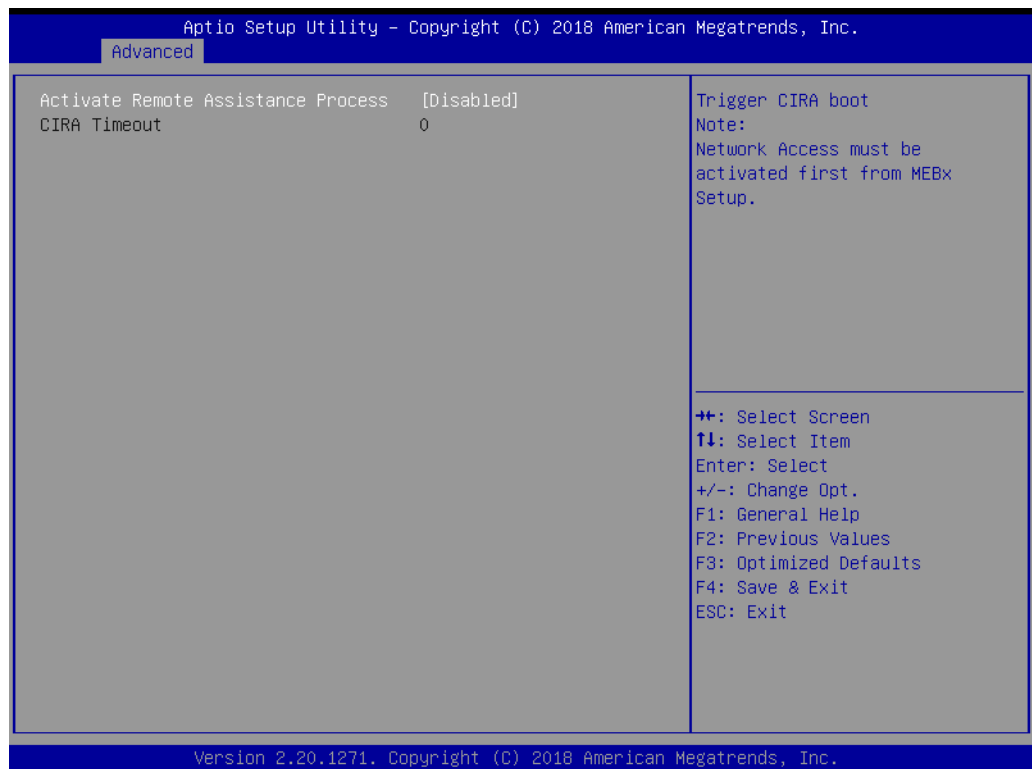

Figure 3.10 CIRA Configuration

- **Activate Remote Assistance Process**
Triggers CIRA boot

■ ASF Configuration

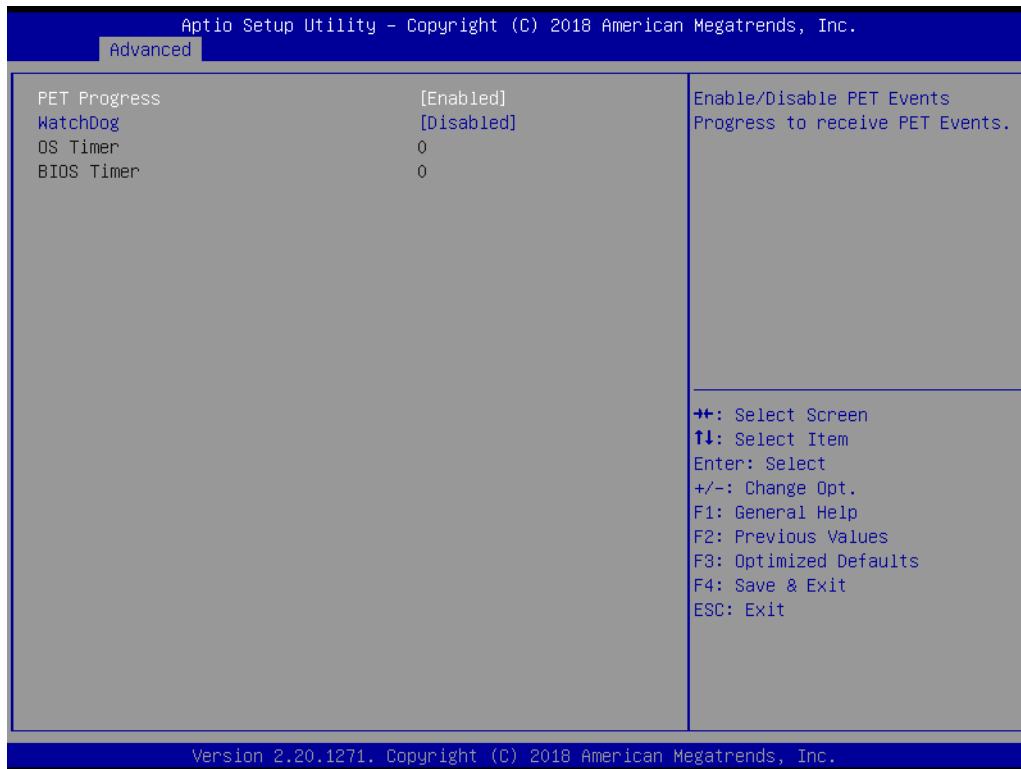

Figure 3.11 ASF Configuration

- **PET Progress**
Enable or Disable PET Progress to receive PET event or not
- **WatchDog**
“Enable or Disable” Watchdog Timer

■ **Secure Erase Configuration**

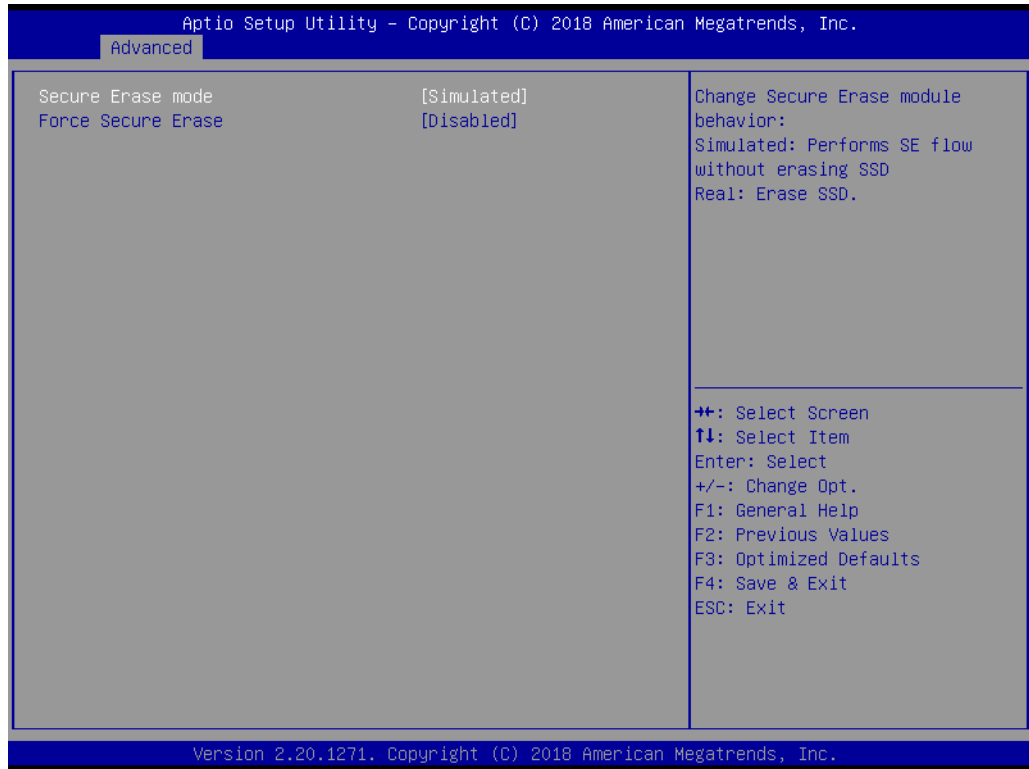

Figure 3.12 Secure Erase Configuration

– **Secure Erase mode**

Change Secure Erase module behavior to “Simulated or Real”.

– **Force Secure Erase**

“Enable or Disable” to force Secure Erase on next boot.

■ **OEM Flags Settings**

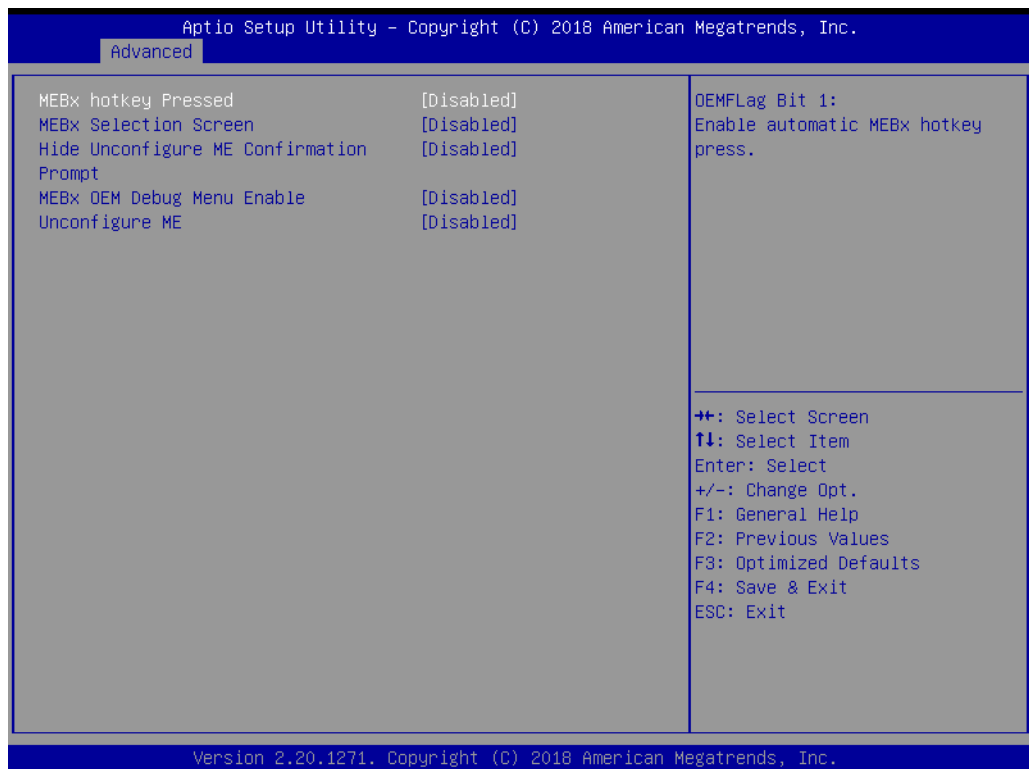

Figure 3.13 OEM Flags Settings

- **BIOS Hotkey Pressed**
Enable or Disable BIOS Hotkey press
- **MEBx Selection Screen**
Enable or Disable MEBx Selection Screen
- **Hide Un-Configure ME Confirmation Prompt**
Hide Un-Configure ME without password confirmation prompt
- **MEBx OEM Debug Menu Enable**
Enable or Disable OEM debug menu in MEBx
- **Unconfigure ME**
Un-Configure ME without password

■ MEBx Resolution Settings

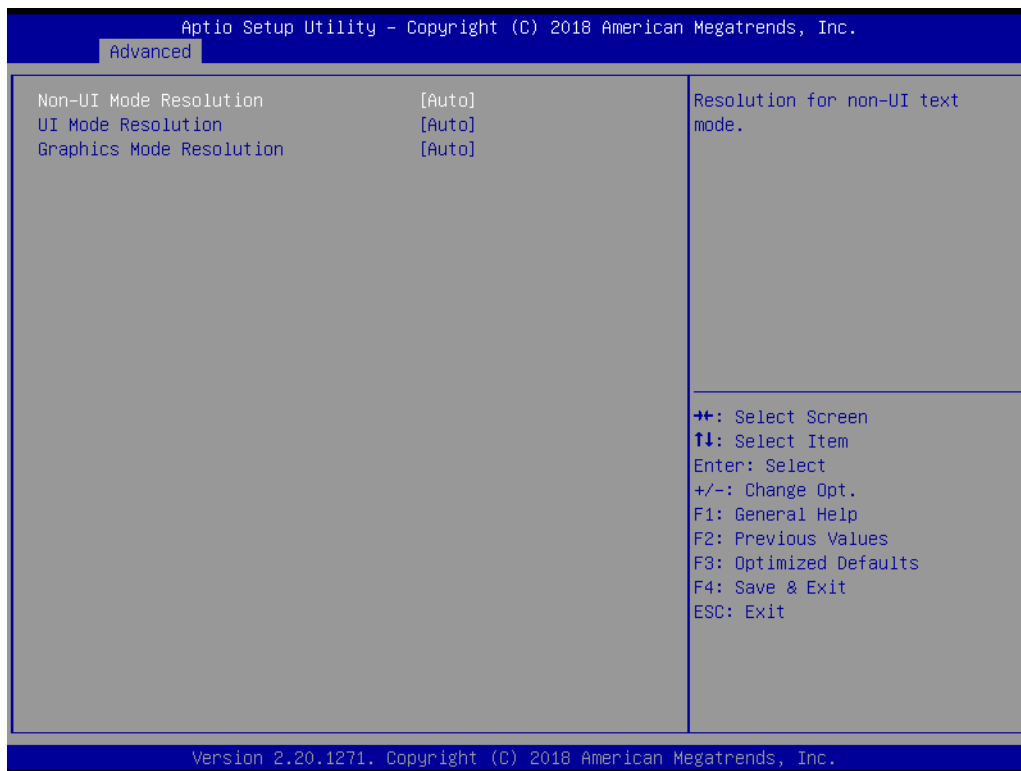

Figure 3.14 MEBx Resolution Settings

- **Non-UI Mode Resolution**
Set resolution for non-UI text mode.
- **UI Mode Resolution**
Set resolution for UI text mode.
- **Graphics Mode Resolution**
Set resolution for graphics mode.

3.2.2.5 Trusted Computing



Figure 3.15 TPM Settings

- **TPM Support**
“Enable or Disable” TPM Support. You can purchase Advantech LPC TPM module to enable TPM function. P/N: PCA-TPM-00B1E.

3.2.2.6 ACPI Settings

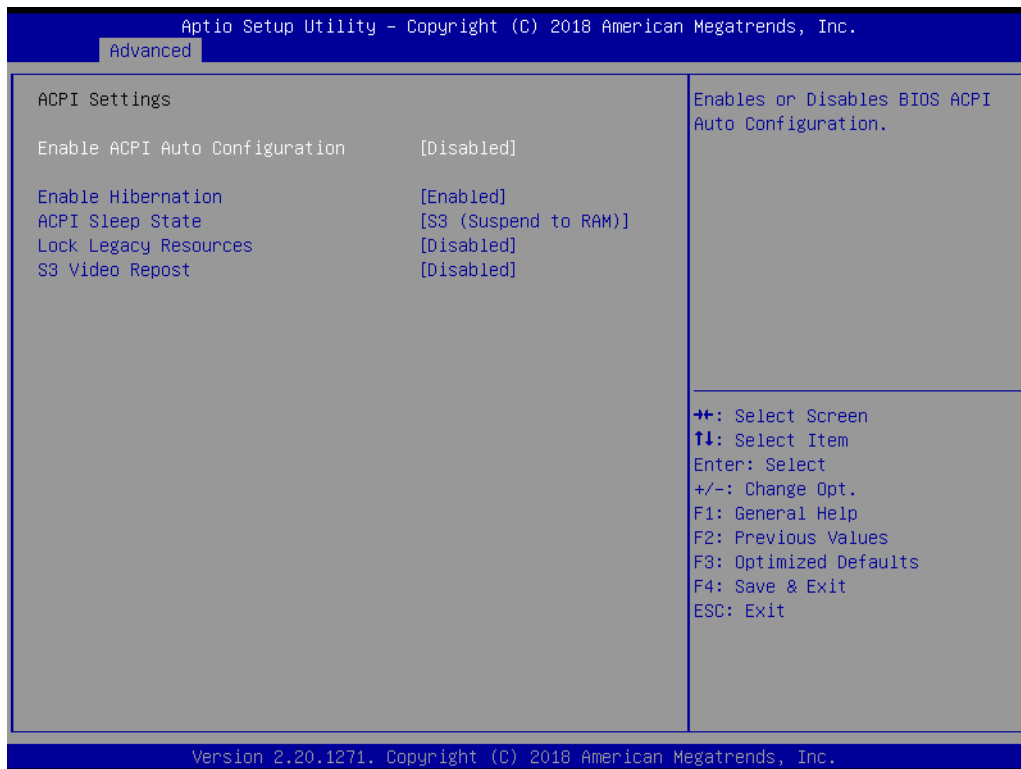

Figure 3.16 ACPI Settings

- **Enable Hibernation**
Enable or Disable Hibernation (OS/S4 Sleep State). This option may not be applied in some OS.
- **ACPI Sleep State**
Auto or S1 only or S3 only ACPI Sleep State.
- **Lock Legacy Resources**
Enable or Disable Lock Legacy Resources.
- **S3 Video Repost**
Enable or Disable S3 Video Repost.

3.2.2.7 SMART Settings

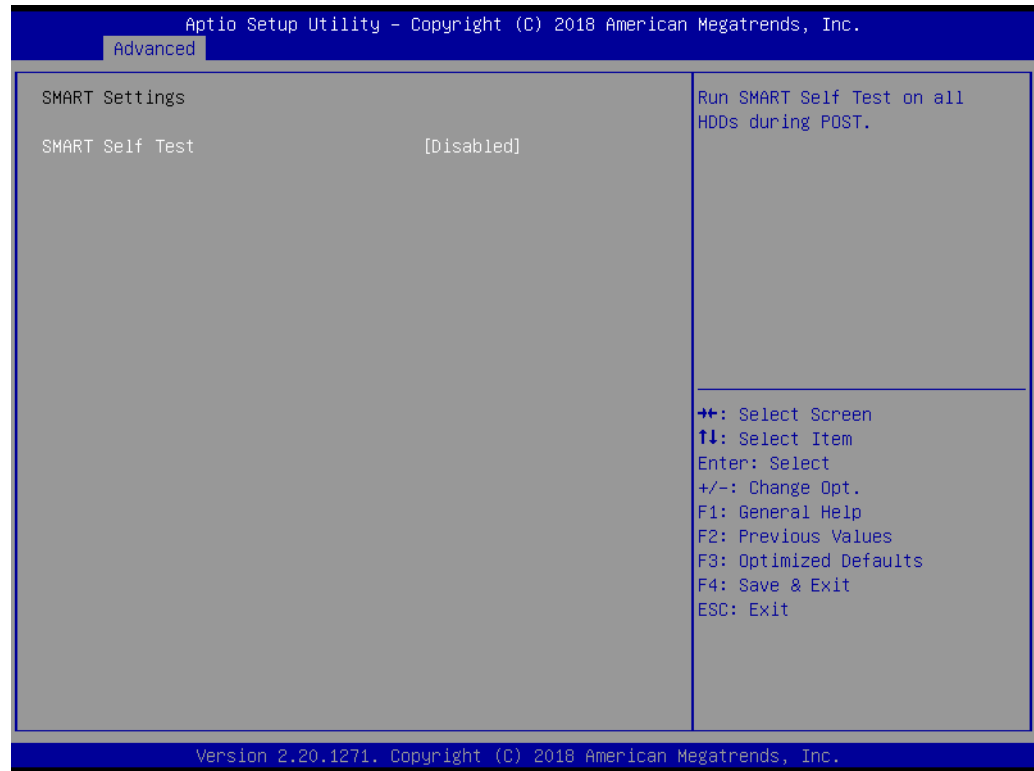

Figure 3.17 SMART Settings

- **SMART Self Test**
Enable or Disable SMART Self Test on all HDDs during POST.

3.2.2.8 Super IO Configuration

MIC-770 supports 2 x RS-232/422/485 on the front side. MIC-770 has 4 more RS-232 (Serial Port 3, 4, 5, 6) via 2x DB9 cables in accessory box.

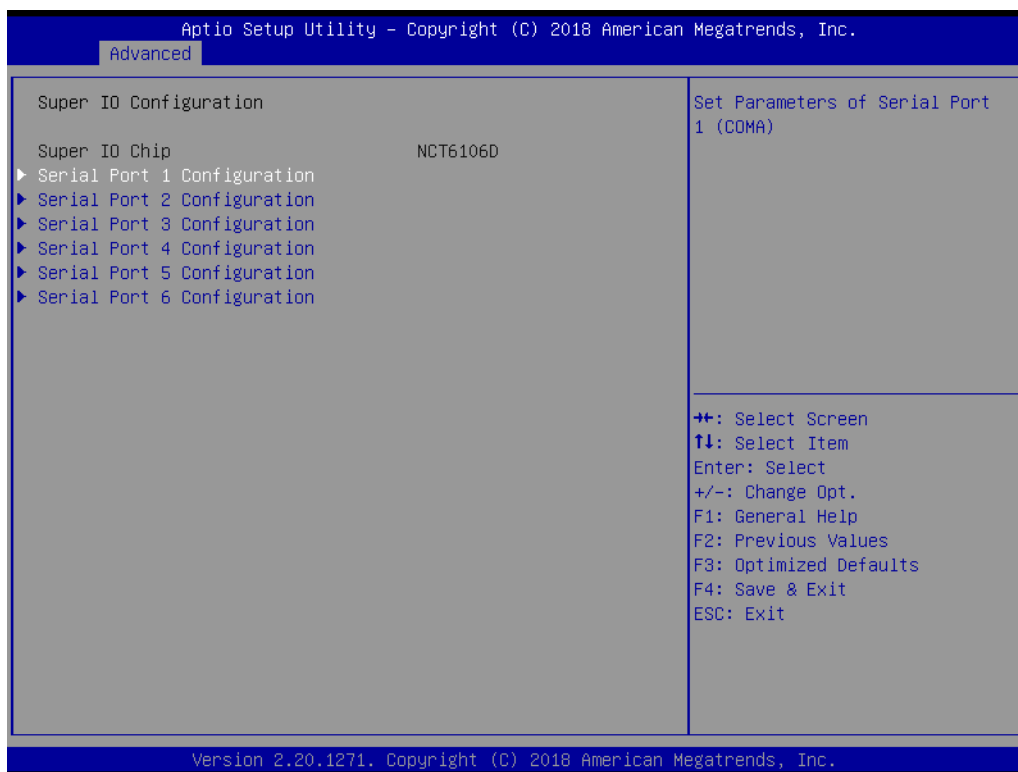

Figure 3.18 Super IO Configuration

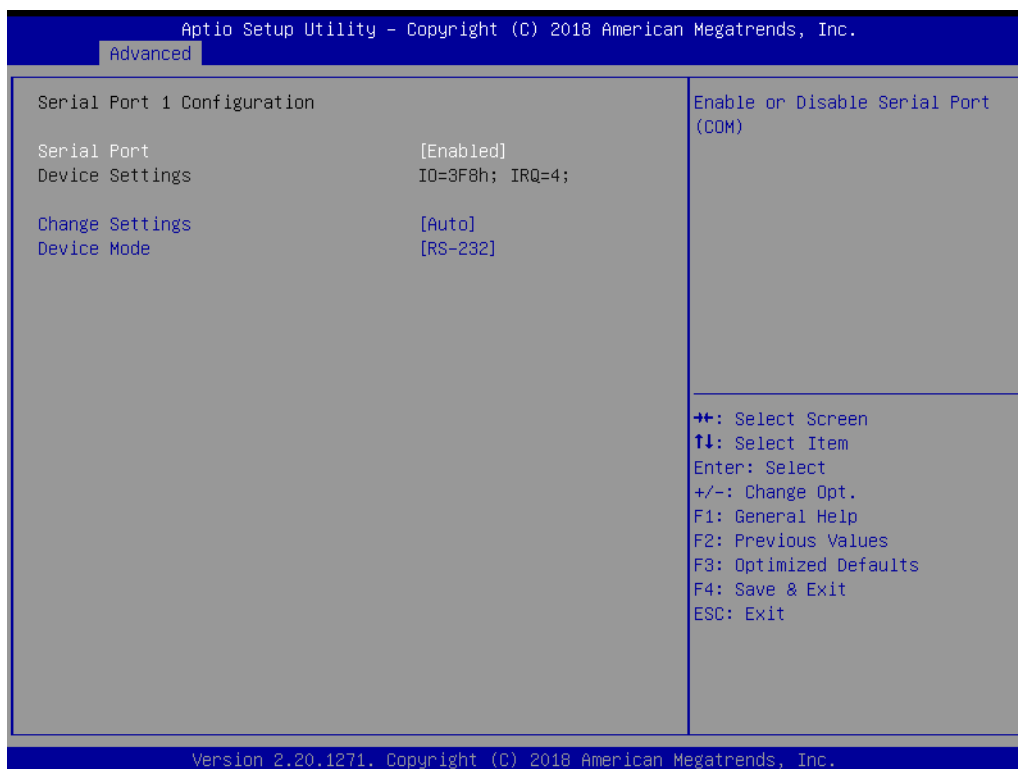

Figure 3.19 Serial Port 1 Configuration

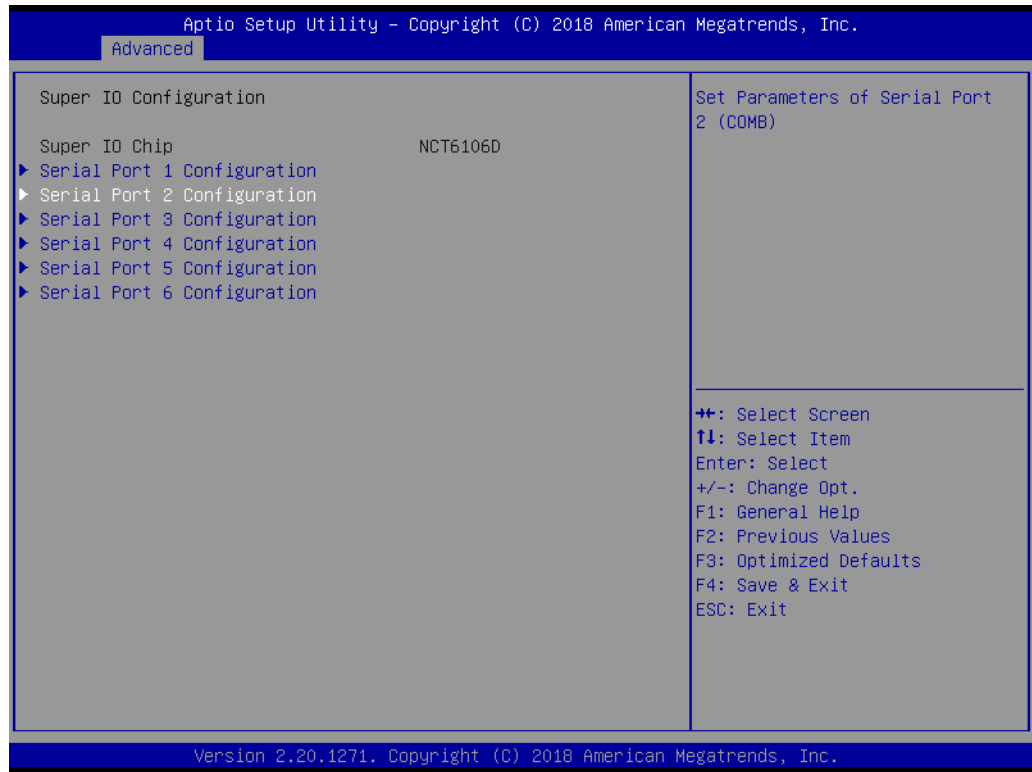

Figure 3.20 Serial Port 2 Configuration



Figure 3.21 Serial Port 3 Configuration

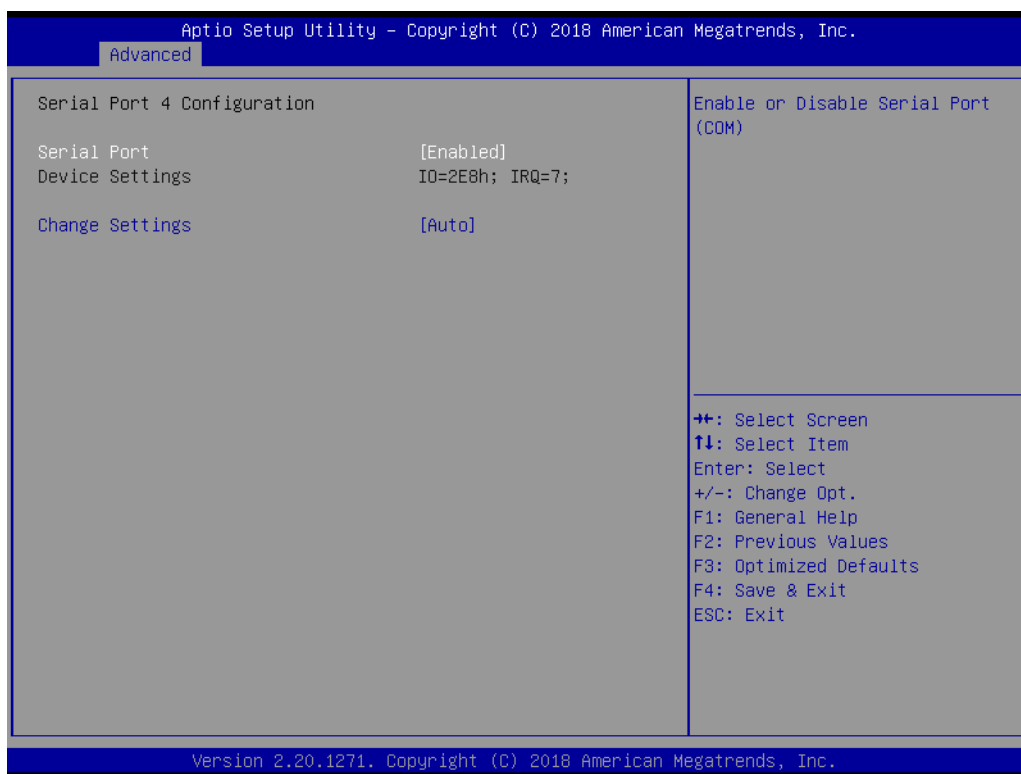

Figure 3.22 Serial Port 4 Configuration

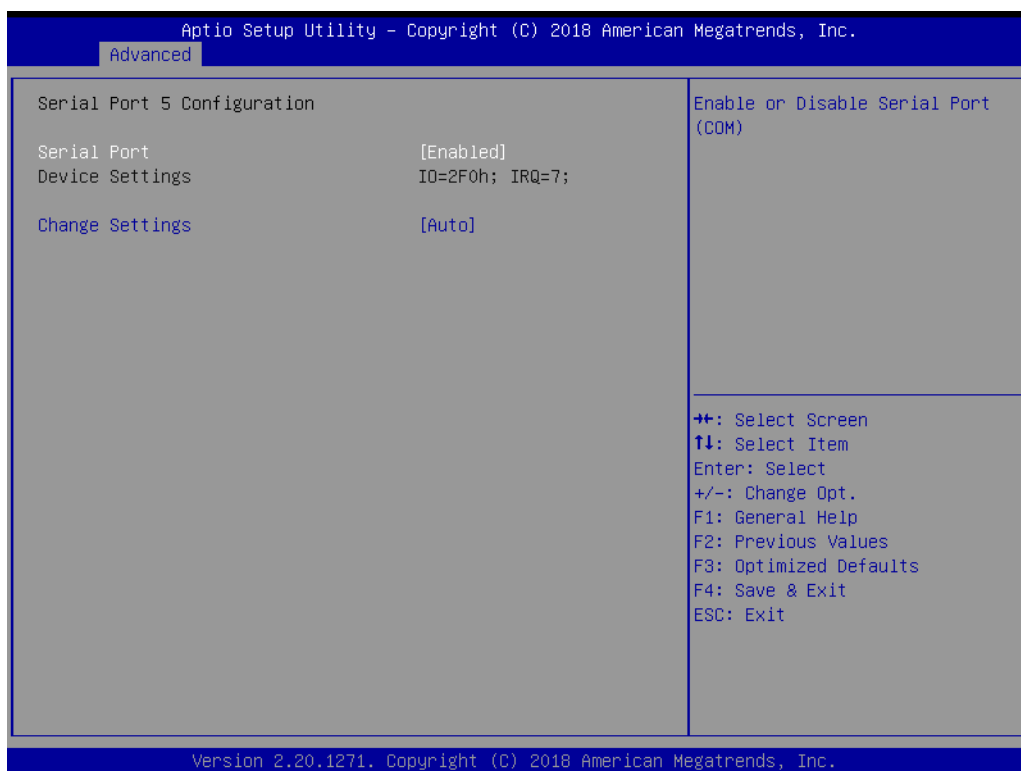

Figure 3.23 Serial Port 5 Configuration



Figure 3.24 Serial Port 6 Configuration

- **Serial Port 1 Configuration**
 - **Serial Port**
This item allows users to enable or disable Serial Port.
 - **Change Settings**
This item allows users to Change Settings of the Serial Ports. The default setting is Auto.
 - **Device Mode**
This item allows users to set the mode of serial port. The default setting is RS-232. When serial port 1 (COM1) is set to RS-485 mode via jumper JSETCOM1, this item should be selected as "RS-485 (Half Duplex)" and further set Auto Direction (Flow) Control setting to "On (enable) or Off (disable)". Default for this Device Mode is "RS-232".
- **Serial Port 2 Configuration**
 - **Serial Port**
This item allows users to enable or disable Serial Port.
 - **Change Settings**
This item allows users to Change Settings of Serial Ports. The default setting is Auto.
 - **Device Mode**
This item allows users to set the mode of serial port. The default setting is RS-232. When serial port 2 (COM2) is set to RS-485 mode via jumper JSETCOM1, this item should be selected as "RS-485 (Half Duplex)" and further set Auto Direction (Flow) Control setting to "On (enable) or Off (disable)". Default for this Device Mode is "RS-232".

- **Serial Port 3 Configuration**
 - **Serial Port**
This item allows users to disable or enable Serial Port.
 - **Change Settings**
This item allows users to change settings of serial ports. The default setting is Auto.

- **Serial Port 4 Configuration**
 - **Serial Port**
This item allows users to disable or enable the Serial Port.
 - **Change Settings**
This item allows users to change settings of the serial ports. The default setting is Auto.

- **Serial Port 5 Configuration**
 - **Serial Port**
This item allows users to disable or enable the Serial Port.
 - **Change Settings**
This item allows users to change settings of the serial ports. The default setting is Auto.

- **Serial Port 6 Configuration**
 - **Serial Port**
This item allows users to disable or enable the Serial Port.
 - **Change Settings**
This item allows users to change settings of the serial ports. The default setting is Auto.

3.2.2.9 H/W Monitor

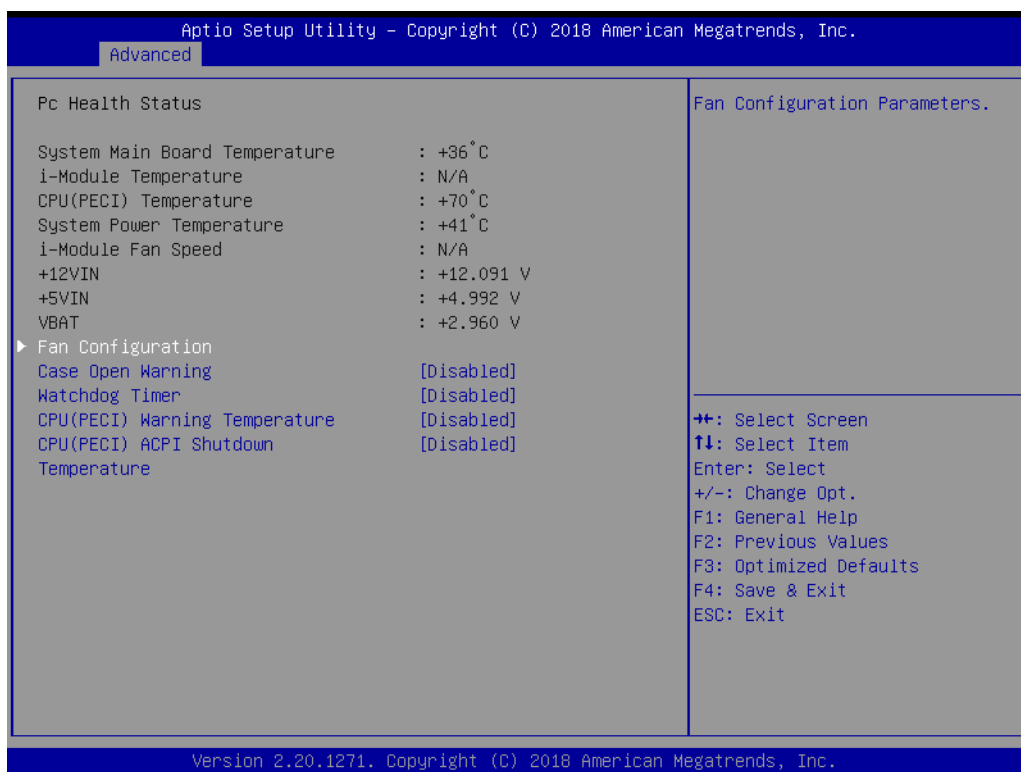

Figure 3.25 PC Health Status

- **Fan Configuration**

To select Manual Mode or SmartFan Mode of I-module FAN

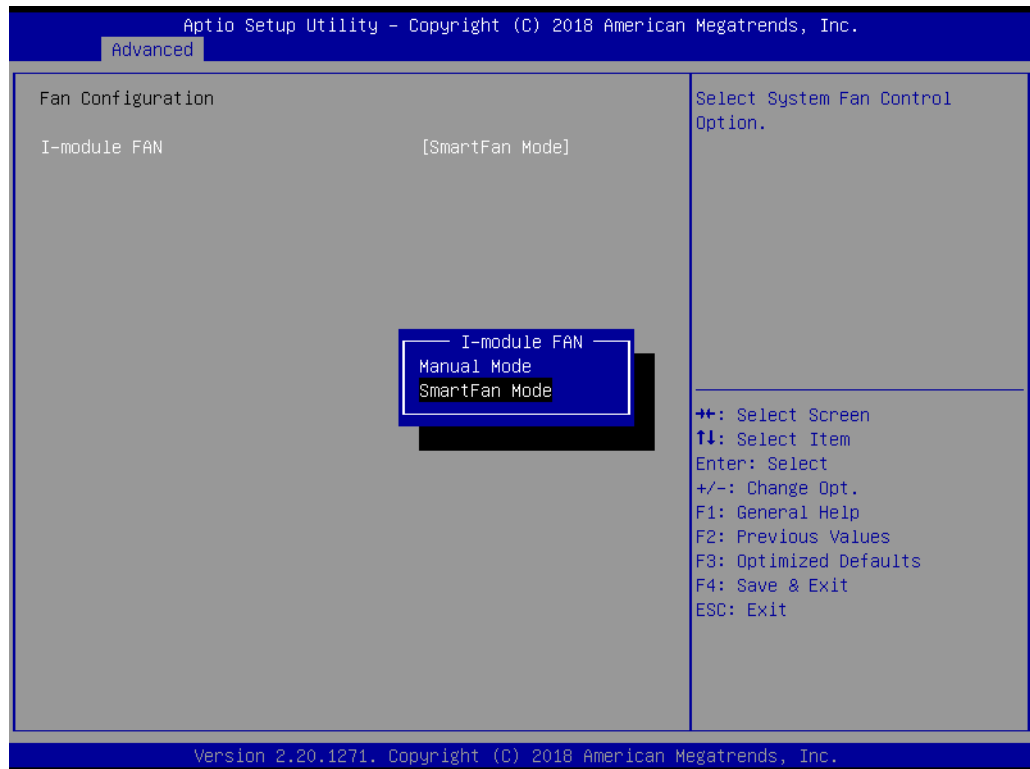

Figure 3.26 Fan Configuration

- **Case Open Warning**

To Enable or Disable the Chassis Intrusion monitoring function. When it is enabled and the case is opened, the speaker beeps.

- **CPU(PECI) Warning Temperature**

Use this item to set the CPU warning temperature. When the system reaches the warning temperature, the speaker will beep.

- **CPU(PECI) ACPI Shutdown**

Use this item to set the ACPI shutdown temperature. When the system reaches the shutdown temperature, it will be automatically shut down by the ACPI OS to protect the system from overheating damage.

- **Watchdog Timer**

To Enable or Disable Watchdog Timer.

3.2.2.10 S5 RTC Wake Settings



Figure 3.27 S5 RTC Wake Settings

- **Wake system with Fixed Time**

To Enable or Disable System wake on alarm event. The system will wake on the hr:min:sec as specified.

3.2.2.11 Serial Port Console Redirection

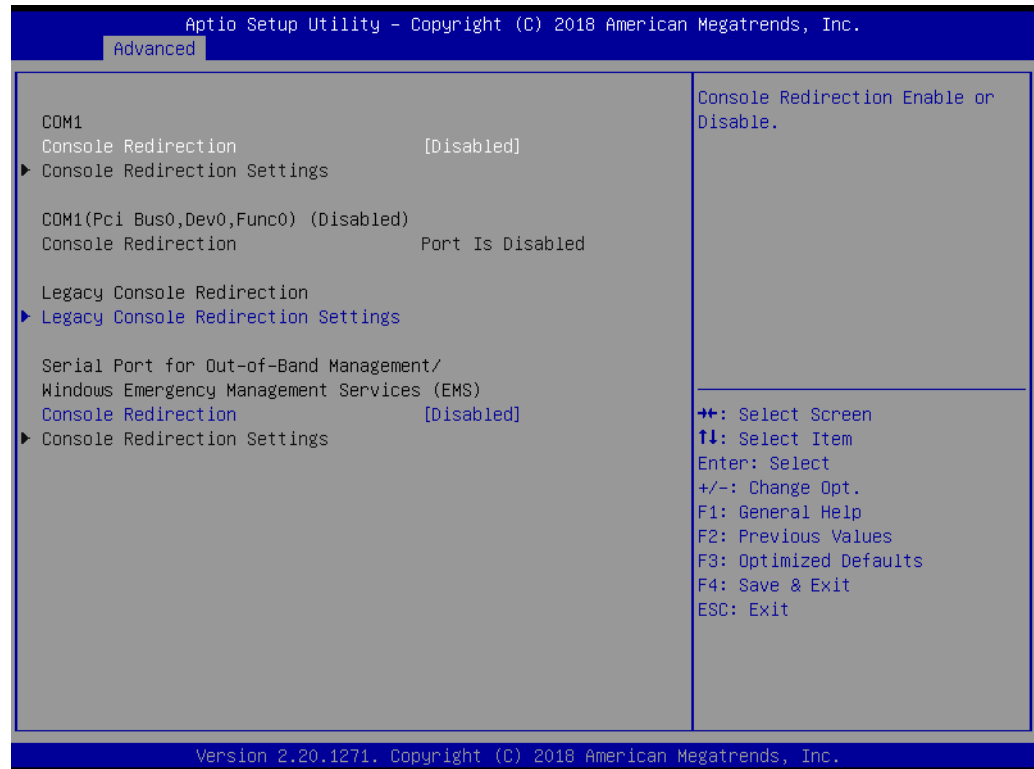

Figure 3.28 Serial Port Console Redirection

- **COM1**
 - **Console Redirection Settings**
Console Redirection Enable or Disable
- **Legacy Console Redirection**
 - **Legacy Console Redirection Settings**
Legacy Console Redirection Settings
- **Serial Port for Out-of-Band Management/ Windows Emergency Management services (EMS)**
 - **Console Redirection**
Console Redirection Enable or Disable

3.2.2.12 Intel TXT Information

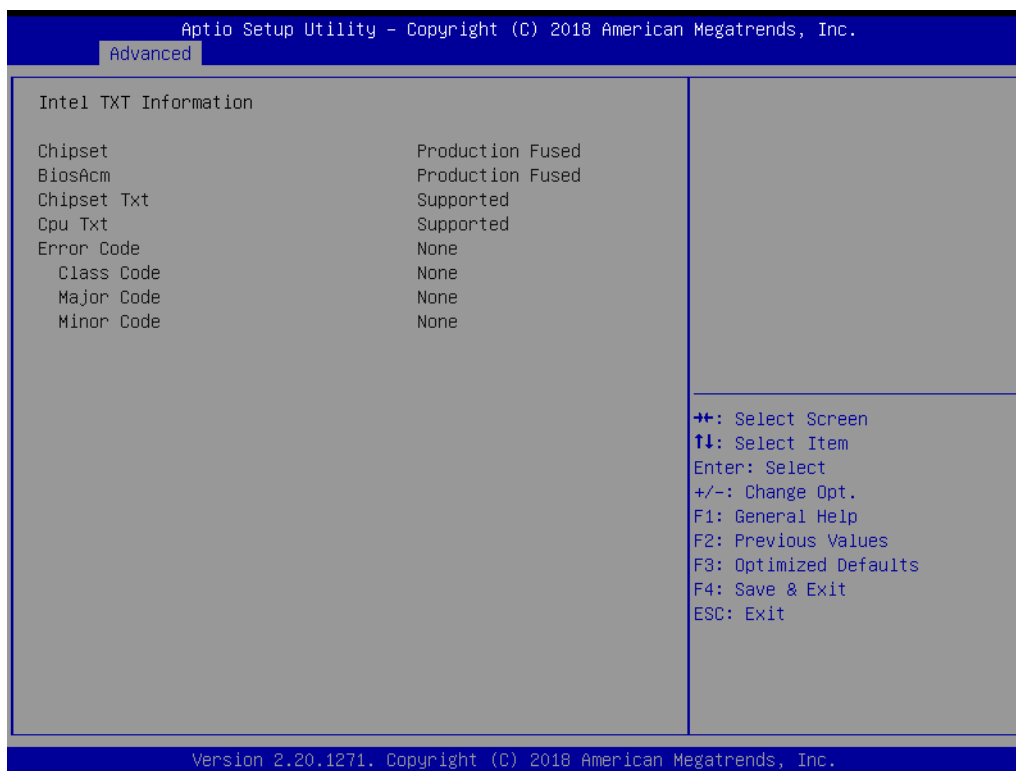

Figure 3.29 Intel TXT Information

3.2.2.13 PCI Subsystem Settings

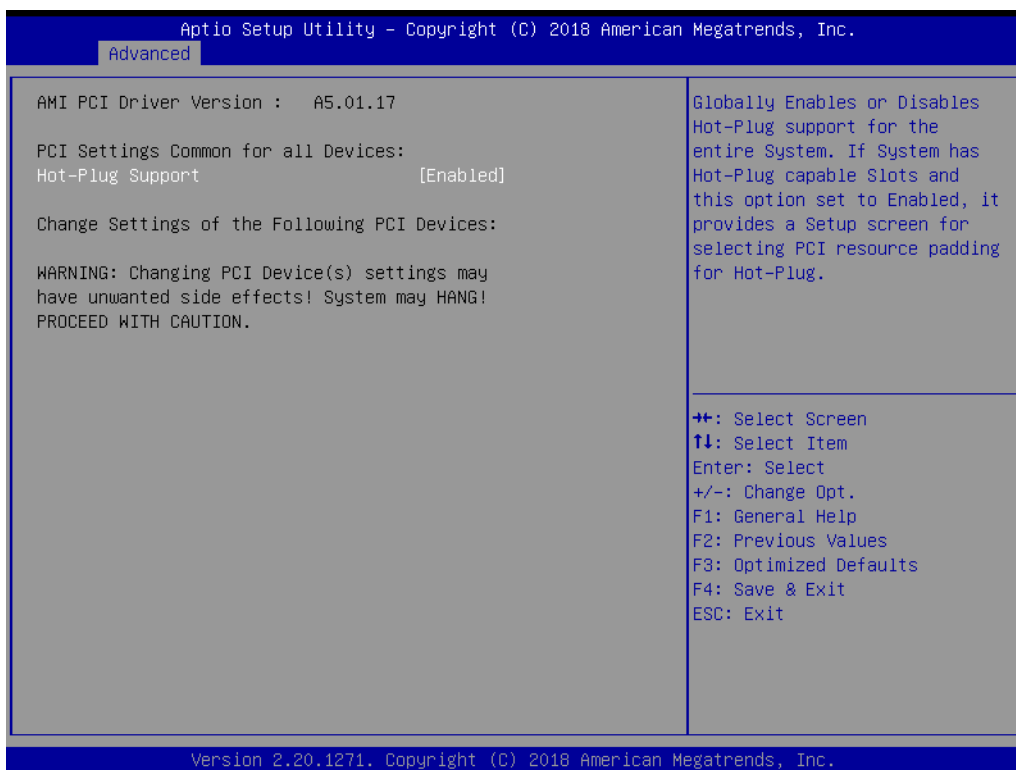

Figure 3.30 PCI Subsystem Settings

- **PCI Settings Common for all Devices – Hot-Plug Support**
"Enable or Disable" PCI hot-plug support for the entire system.

3.2.2.14 CSM Configuration

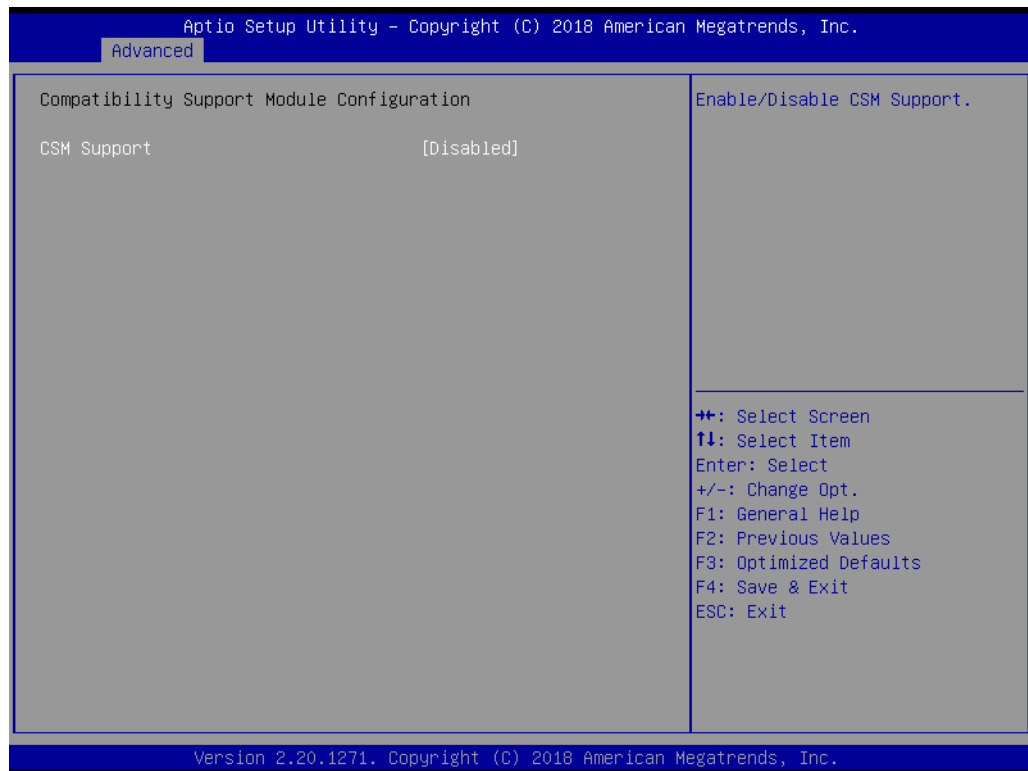

Figure 3.31 CSM Configuration

- **Compatibility Support Module Configuration**
 - **CSM Support**
Enable/Disable CSM Support.
- **CSM16 Module Version**
 - **GateA20 Active**
Upon Request - GA20 can be disabled using BIOS services. Do not allow disabling GA20; this option is useful when any RT code is executed above 1MB.
 - **Option ROM Message**
Set display mode for Option ROM.
 - **INT19 Trap Response**
BIOS reaction on INT19 trapping by Option ROM: Immediate - execute the trap right away; Postponed - execute the trap during legacy boot.
 - **Boot option filter**
This option controls Legacy/UEFI ROMs Priority.
- **Option ROM execution**
 - **Network**
Controls the execution of UEFI and Legacy PXE OpROM.
 - **Storage**
Controls the execution of UEFI and Legacy Storage OpROM.
 - **Video**
Controls the execution of UEFI and Legacy Video OpROM.
 - **Other PCI devices**
Determines OpROM execution policy for devices other than Network, Storage, or Video.

3.2.2.15 USB Configuration

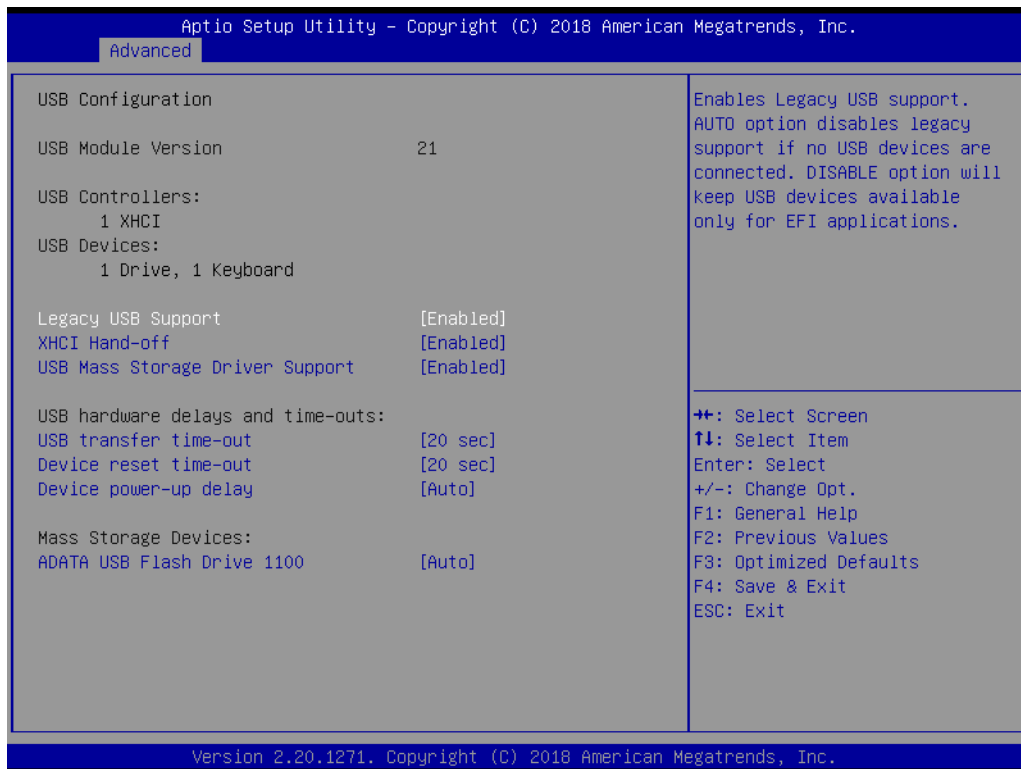

Figure 3.32 USB Configuration

- **Legacy USB Support**
This is for supporting USB device under legacy OS such as DOS. When choosing Auto, the system will automatically detect if any USB device is plugged into the computer and enable USB legacy mode when a USB device is plugged and disable USB legacy mode when no USB device is plugged.
- **XHCI Hand-off**
This is a workaround for OS without XHCI hand-off support. The XHCI ownership change should be claimed by XHCI driver.
- **USB Mass Storage Driver Support**
Enable or Disable USB Mass Storage driver support.
- **USB transfer time-out**
Allows you to select the USB transfer time-out value. [1,5,10,20sec]
- **Device reset time-out**
Allows you to select the USB device reset time-out value. [10,20,30,40sec]
- **Device power-up delay**
Maximum time the device will take before it properly reports itself to the Host Controller. Auto uses default value: for a Root port it is 100 ms, for a Hub port the delay is take from Hub descriptor.

3.2.2.16 USB Network Stack Configuration



Figure 3.33 Network Stack

- **Network Stack**
"Enable or Disable" UEFI Network Stack.

3.2.3 Chipset



Figure 3.34 Chipset

This page provides information of the chipset on MIC-770.

3.2.3.1 System Agent (SA) Configuration

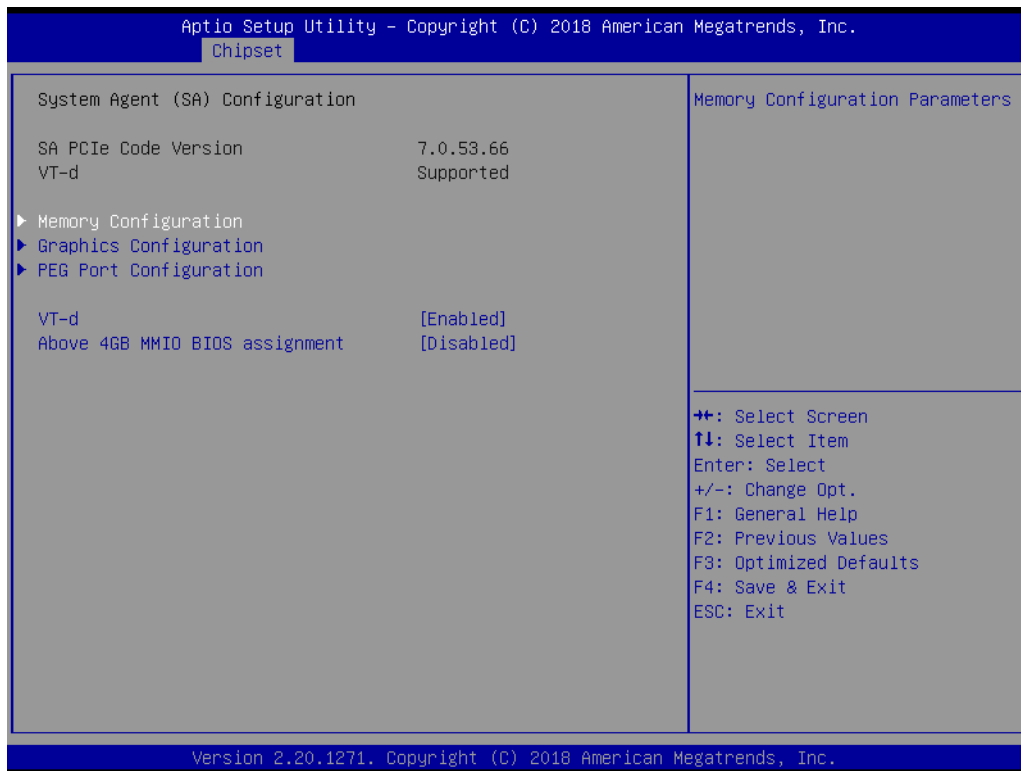
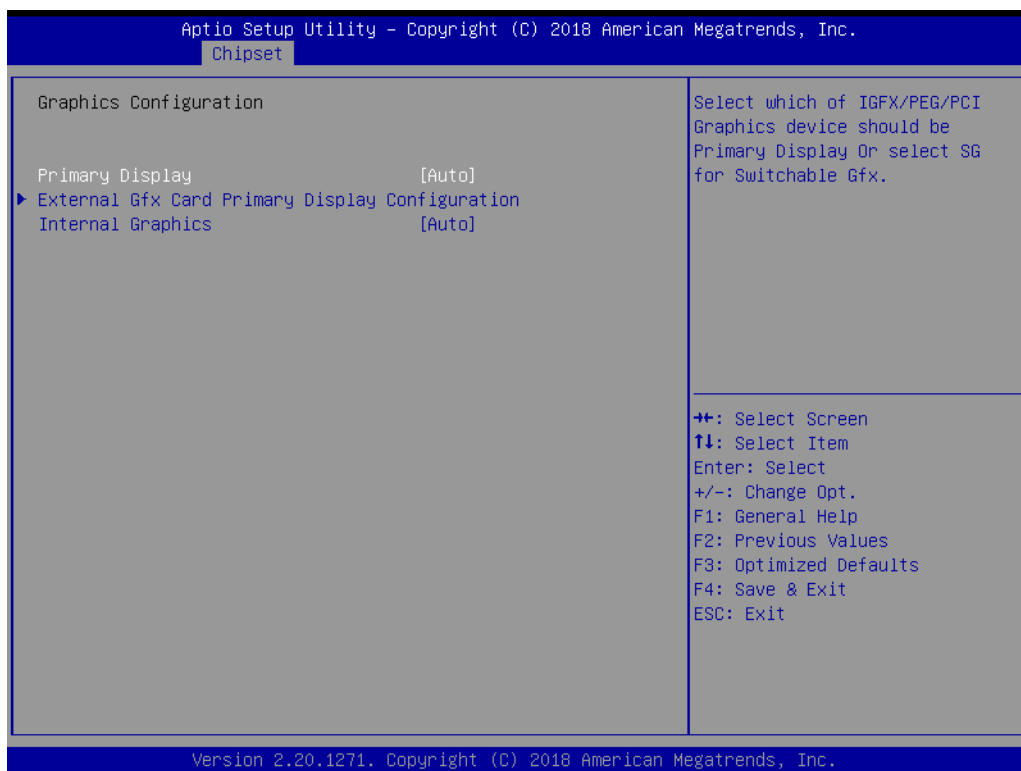

Figure 3.35 System Agent (SA) Configuration

3.2.3.2 Graphics Configuration



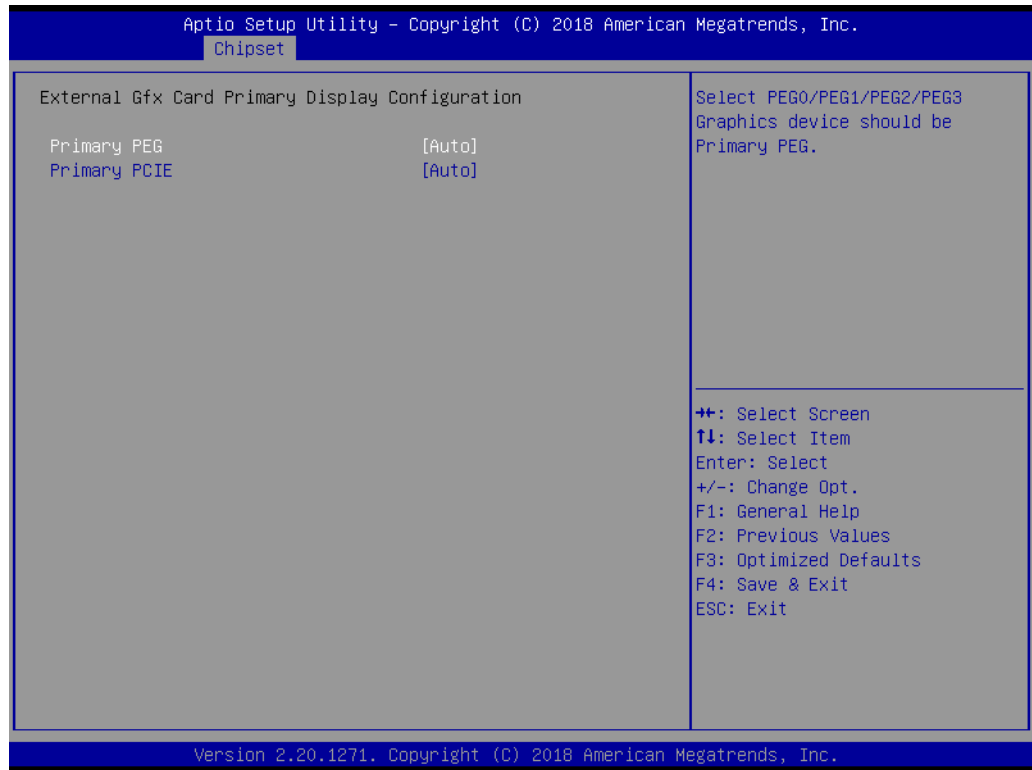

Figure 3.36 Graphics Configuration

- **Primary Display**
Set Primary Display to "Auto", "IGFX", "PEG", "PCI", or "SG".
- **Primary Display**
Select PEG0/PEG1/PEG2/PEG3 graphics device should be Primary PEG.
- **External Gfx Card Primary Display Configuration**
- **Primary PEG**
Select Auto/PEG11/PEG12
- **Primary PCIE**
Select Auto/PCIE1~PCIE19
- **Internal Graphics**
Auto or Disable or Enable Internal Graphics.

3.2.3.3 PEG Port Configuration

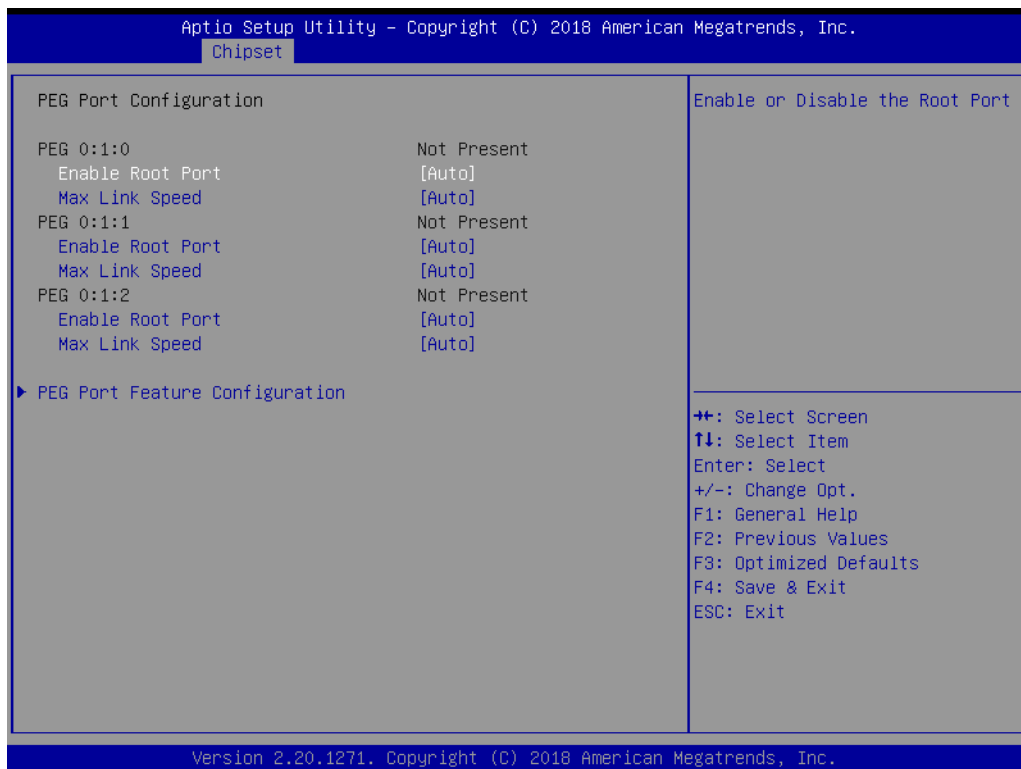

Figure 3.37 PEG Port Configuration



Figure 3.38 PEG Port Feature Configuration

- **Enable Root Port**
Enable or disable the root port
- **Max Link speed**

Configure PEG 0:1:0 max speed

PEG Port Feature Configuration

- Detect Non-Compliance Device

Detects non-compliance PCI Express device in PEG. If enabled, it will take more time during POST phase.

3.2.3.4 Memory Configuration

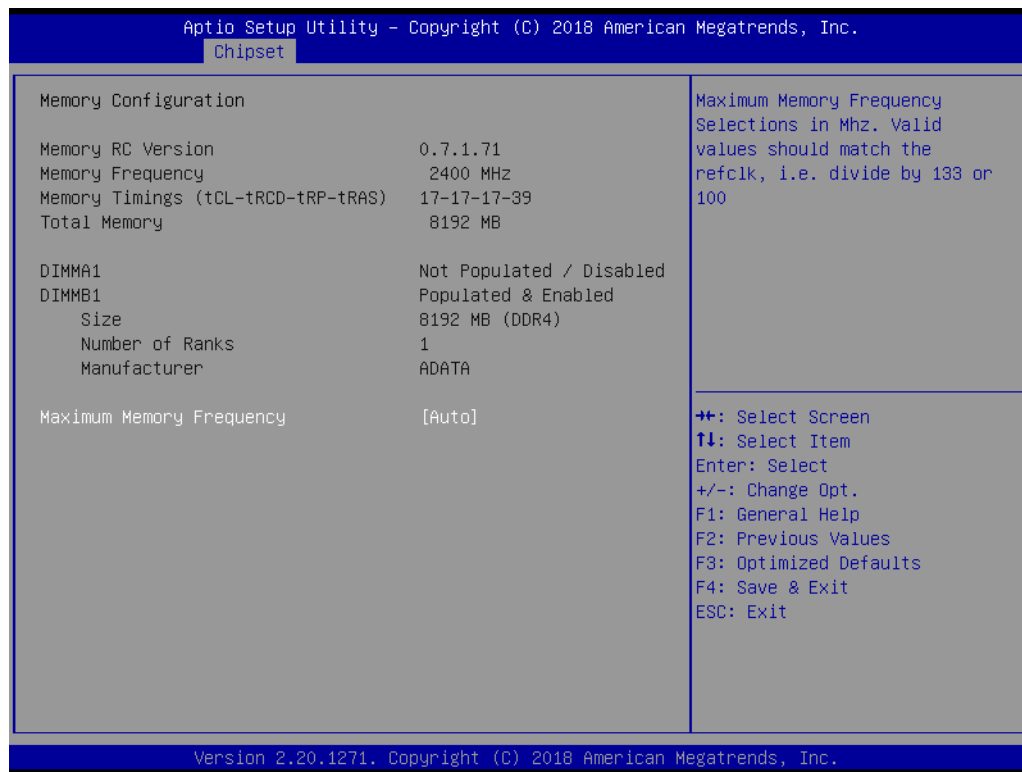

Figure 3.39 Memory Configuration

- **Maximum Memory Frequency**
Maximum memory frequency selections in Mhz.

3.2.3.5 PCH-IO Configuration

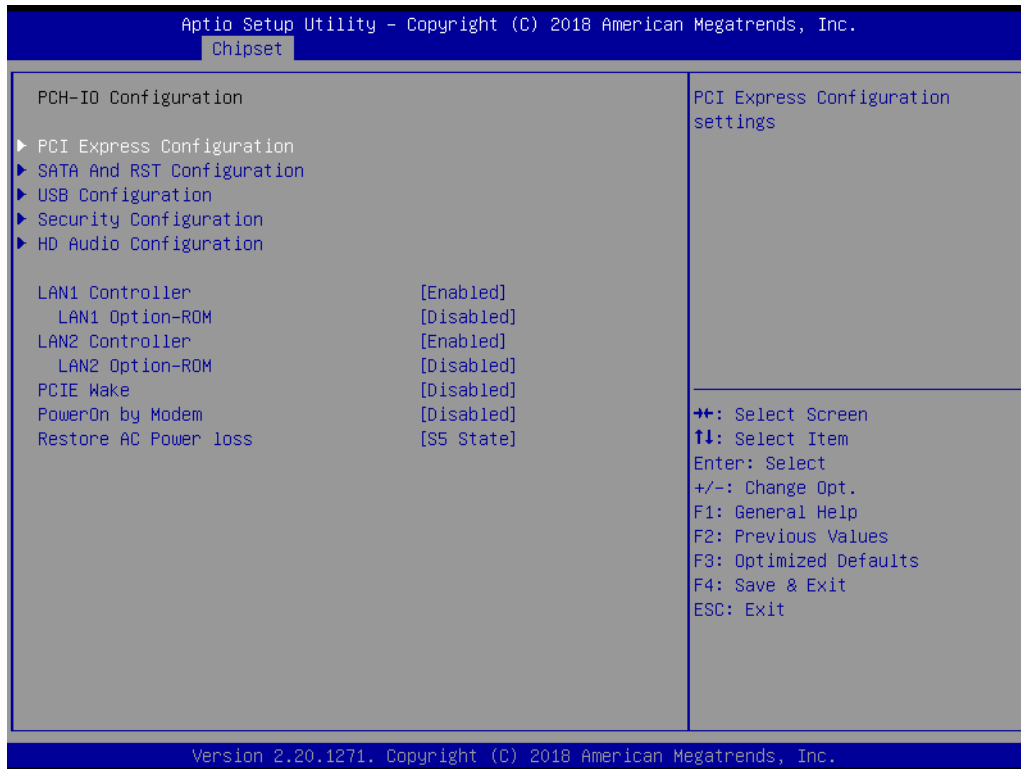

Figure 3.40 PCH-IO Configuration

- **LAN1 Controller**
Enable or Disable LAN1 controller.
- **LAN 1 Option-ROM**
Enable or Disable LAN 1 boot option for legacy network devices.
- **LAN2 Controller**
Enable or Disable LAN2 controller.
- **LAN 2 Option-ROM**
Enable or Disable LAN 2 boot option for legacy network devices.
- **PCIE Wake**
Enable or Disable PCIE to wake the system from S5.
- **PowerOn by Modem**
"Enable and Disable" PowerOn by Modem
- **Restore AC Power Loss**
Power off or Power on or Last State to restore AC Power Loss

3.2.3.6 PCI Express Configuration

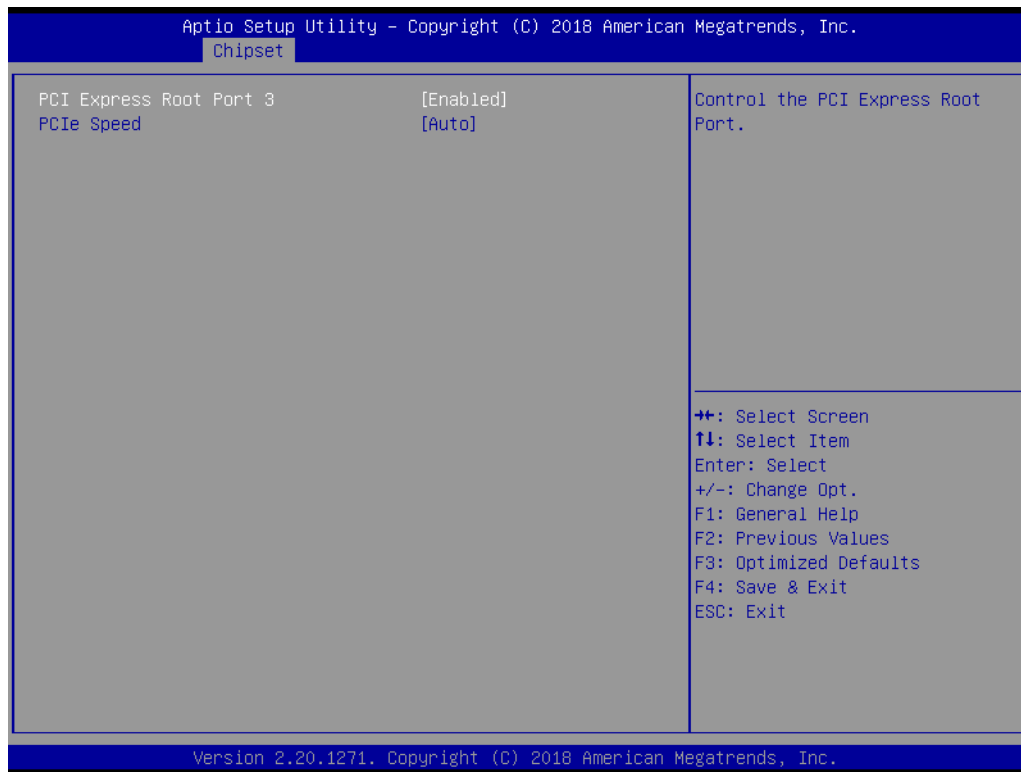
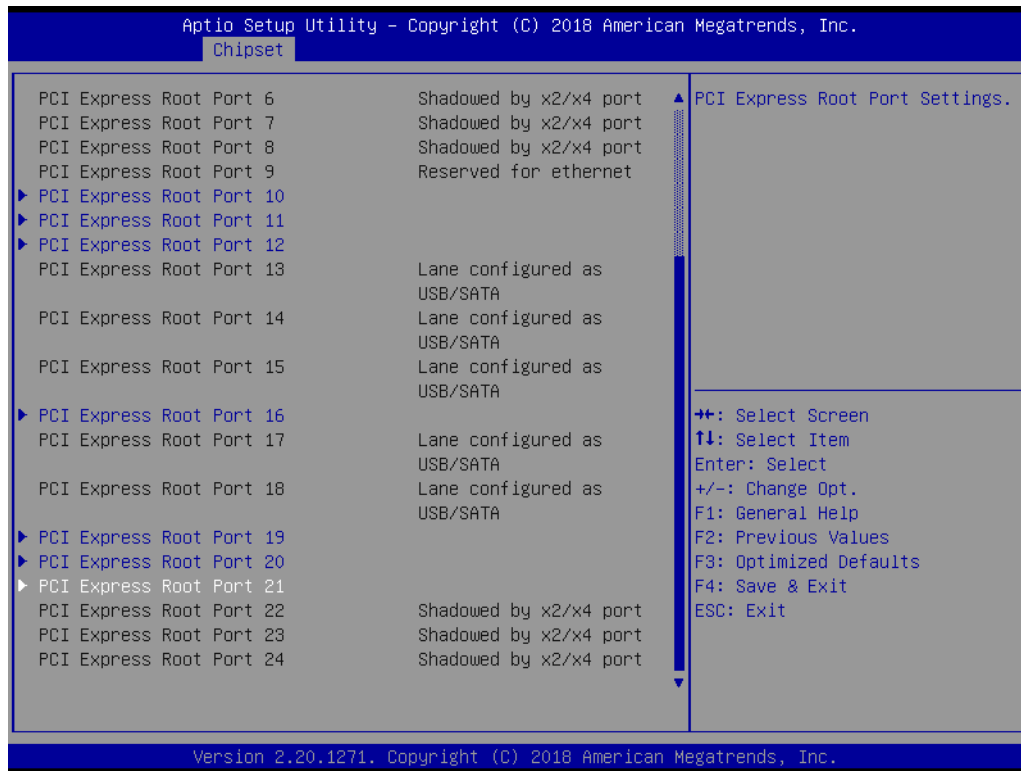

Figure 3.41 PCI Express Root Port Setting

- **PCI Express Root Port 1**
Enable or Disable PCI Express Root Port.
- **PCIe Speed**
Select "Auto, Gen1, Gen2, Gen3" for PCIe Speed

3.2.3.7 SATA and RST Configuration

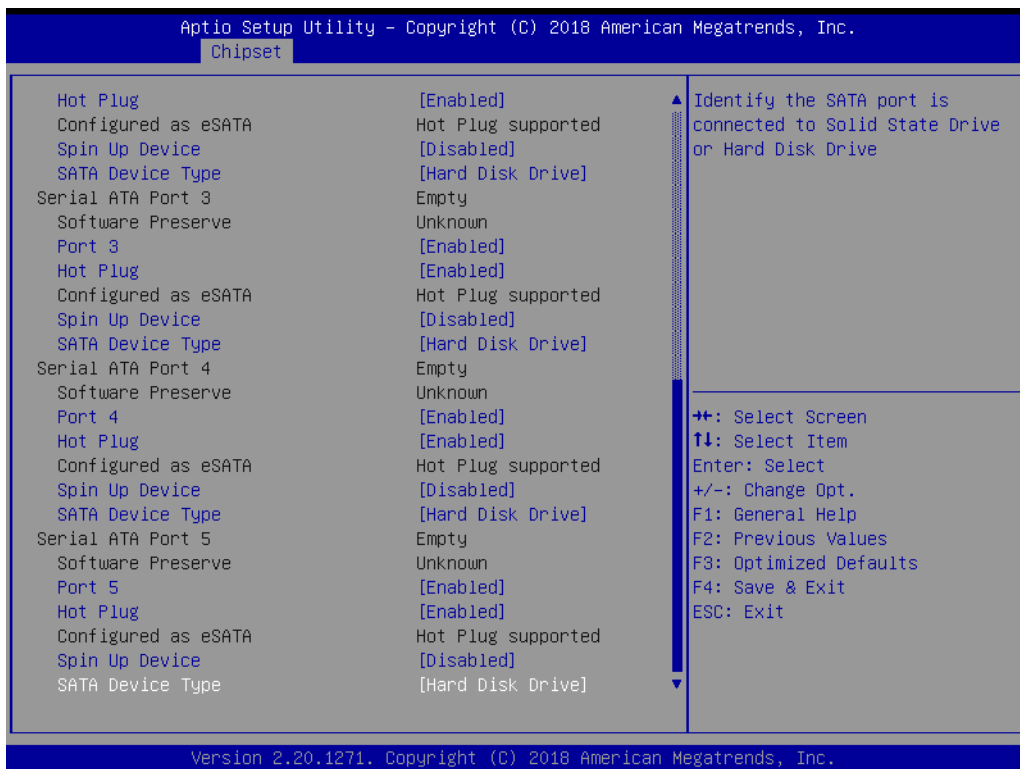
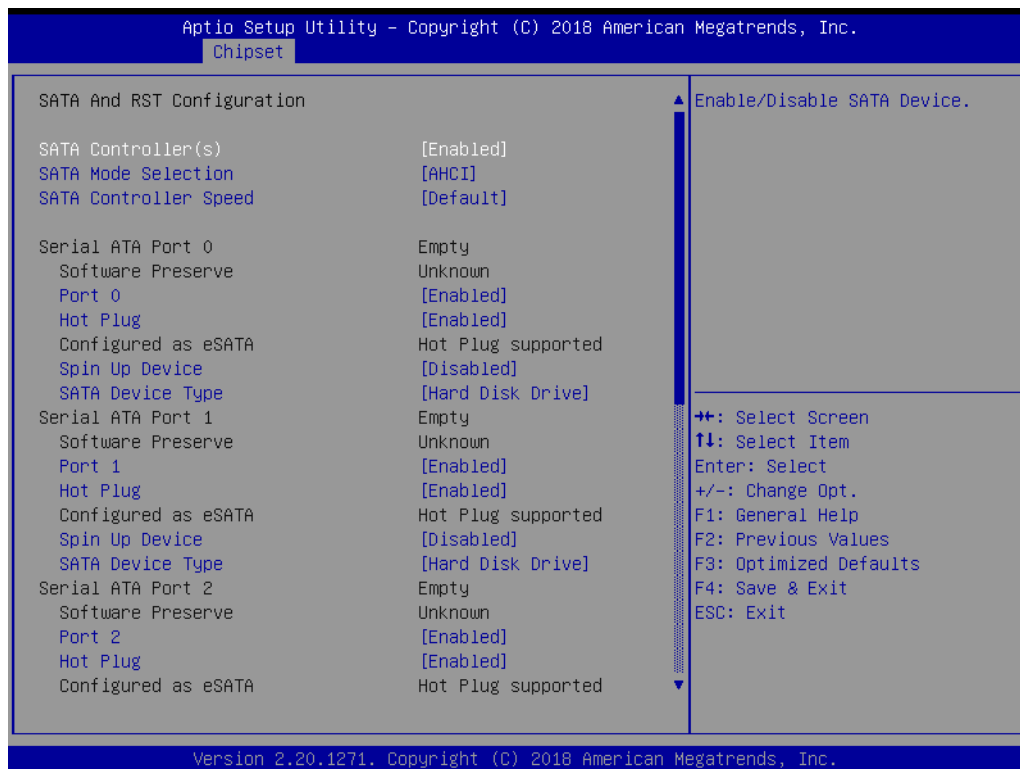

Figure 3.42 SATA Configuration

- **SATA Controller(s)**
Enable or Disable SATA Controller
- **SATA Mode Selection**
This can be configured as RAID or AHCI.

- **SATA Controller Speed**
Indicates the maximum speed the SATA controller can support by selecting Default, Gen1, Gen2, Gen3.
- **Port 0~5**
Enable or Disable SATA port 0~5.
- **Hot Plug**
Enable or Disable SATA Hot-Plug
- **Spin up Device**
Enable or Disable spin up device
- **SATA Device Type**
To identify the SATA that is connected to a Solid State or Hard Disk Drive.

3.2.3.8 USB Configuration

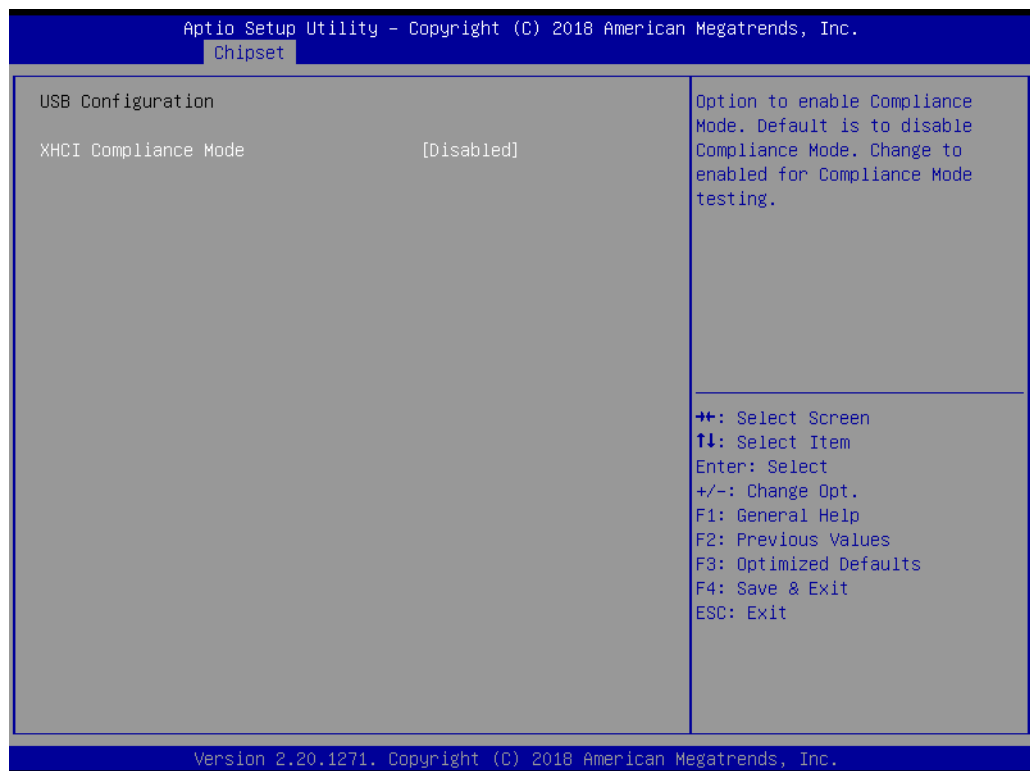

Figure 3.43 USB Configuration

- **XHCI Compliance mode**
Option to "Enable or Disable" XHCI compliance mode. Default is to disable compliance mode.

3.2.3.9 HD Audio Configuration

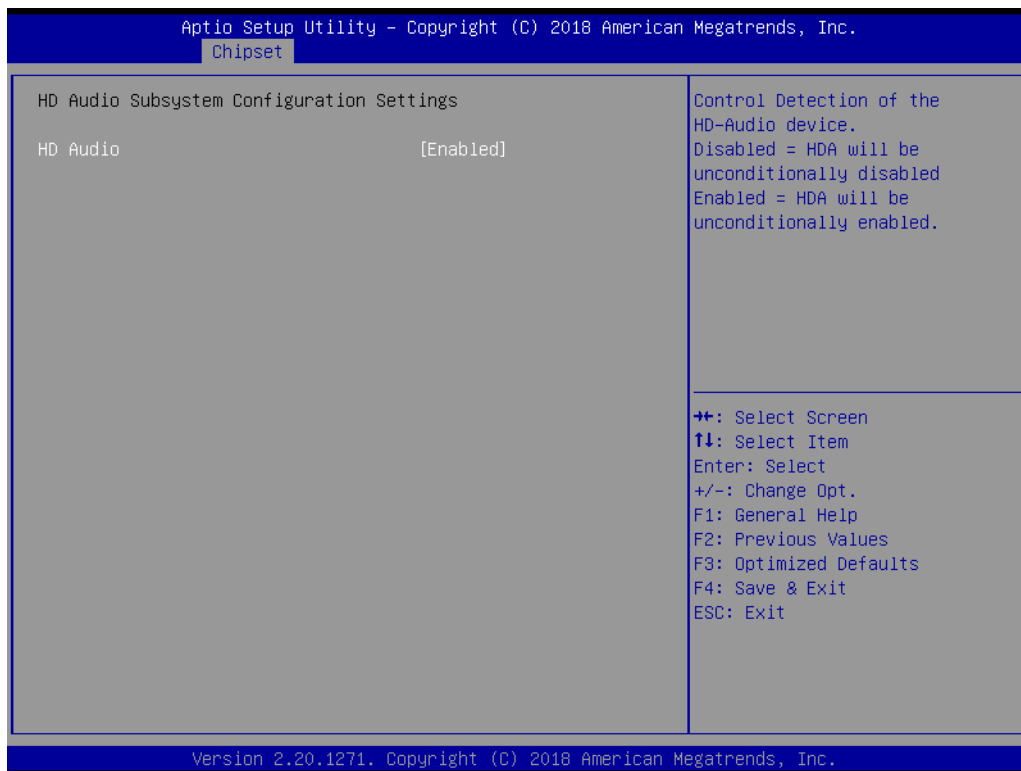

Figure 3.44 HD Audio Configuration

- **HD Audio**
Control detection of the HD-Audio device.
Disable = HDA will be unconditionally disabled
Enable=HDA will be unconditionally enabled

3.2.3.10 Security Configuration

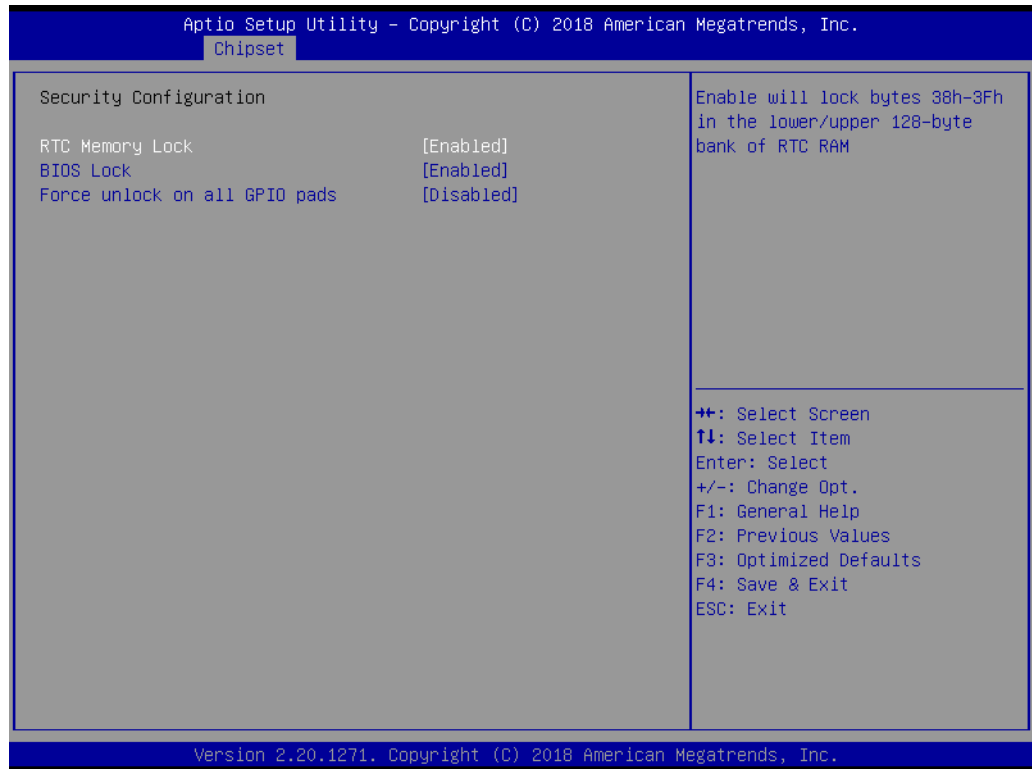

Figure 3.45 Security Configuration

- **RTC Memory Lock**
Enable will lock bytes 38h-3Fh in the lower/upper 128-byte bank of RTC RAM.
- **BIOS Lock**
"Enable or Disable" the PCH BIOS Lock Enable feature. Required to be enabled to ensure SMM protection of flash.
- **Force unlock on all GPIO pads**
If Enabled, BIOS will force all GPIO pads to be in an unlocked state.

3.2.4 Security

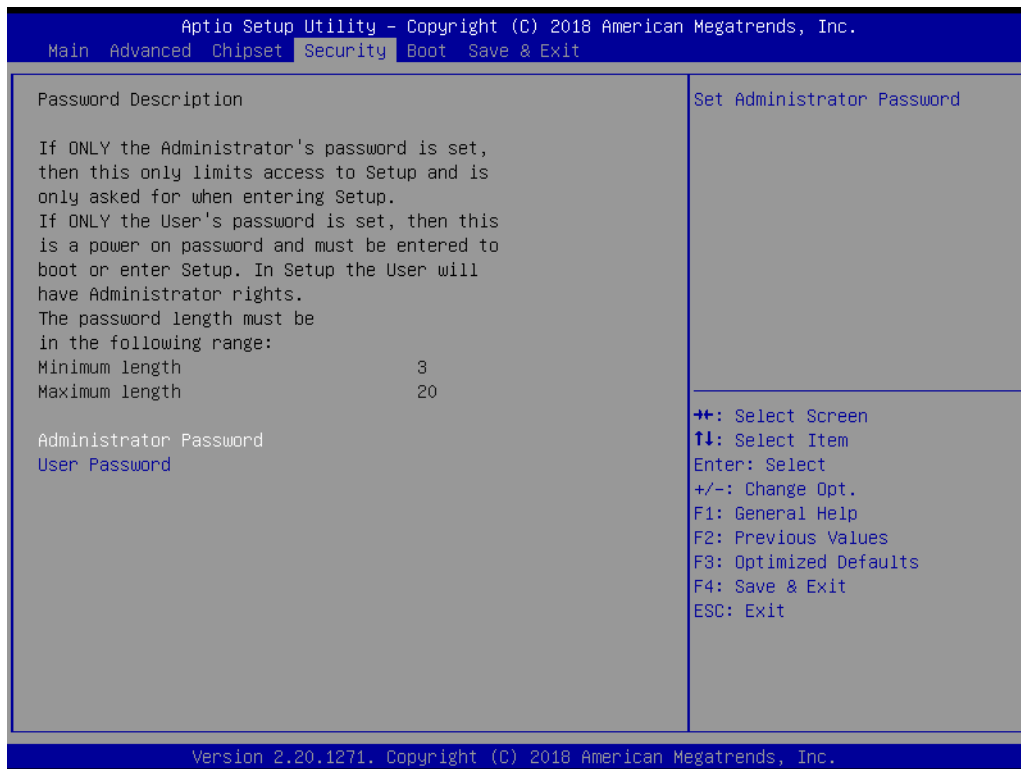

Figure 3.46 Security

Select Security Setup from the MIC-770 Setup main BIOS setup menu. All Security Setup options, such as password protection is described in this section. To access the sub menu for the following items, select the item and press <Enter>.

Note! *If only the User's password is set, the User will have Administrator rights. To set Administrator password is strongly recommended if you have security concerns.*



3.2.5 Boot

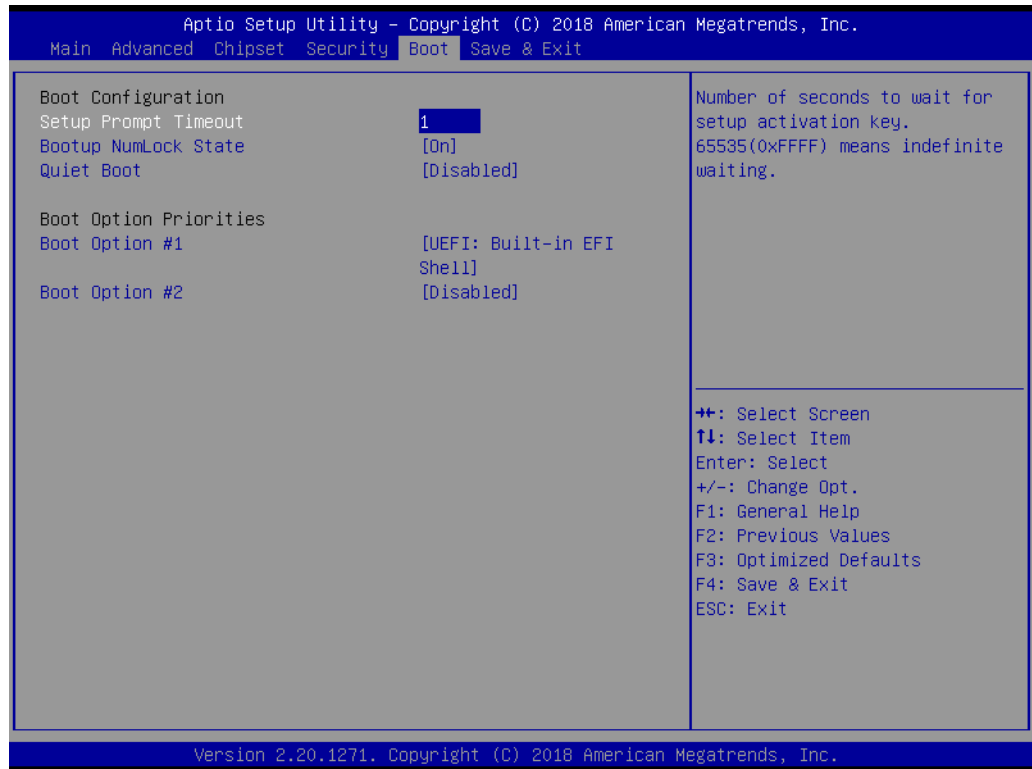

Figure 3.47 Boot

- **Setup Prompt Timeout**
Use the <+> and <-> keys to adjust the number of seconds to wait for setup activation key.
- **Bootup NumLock State**
“On or Off” power-on state for the NumLock.
- **Quiet Boot**
Enable or Disable Quiet Boot option.
- **Boot Option Priorities**
Sets the boot order.
- **Hard Drive BBS Priorities**
Sets the order of the legacy devices on this group.

3.2.6 Save & Exit

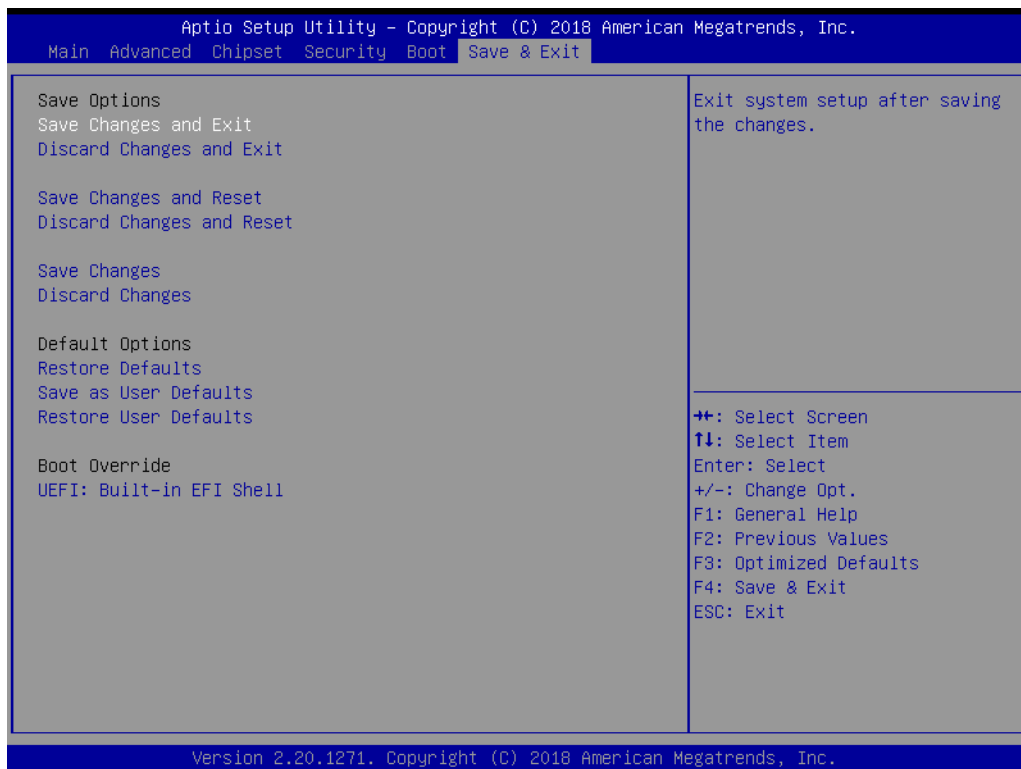

Figure 3.48 Save & Exit

Save Changes and Exit

When you complete system configuration, select this option to save your changes, exit BIOS setup and reboot the computer so the new system configuration parameters can take effect.

1. Select Exit Saving Changes from the Exit menu and press <Enter>. The following message appears:
 Save Configuration Changes and Exit Now?
 [Yes] [No]
2. Select Yes or No.

Discard changes and exit

Select this option to quit Setup without making any permanent changes to the system configuration.

1. Select Exit Discarding Changes from the Exit menu and press <Enter>. The following message appears:
 Quit without saving?
 [Yes] [No]
2. Select Yes to discard changes and exit.

Discard Changes

Select Discard Changes from the Exit menu and press <Enter>.

Chapter 4

Software Installation

This chapter introduces driver installation.

4.1 Before you begin

To facilitate the installation of the enhanced display drivers and utility software, read the instructions in this chapter carefully. The drivers for the MIC-770 are located on the software installation CD.

Note! For system stability, installing the drivers in the following sequence is highly recommended:



- Chipset
- Graphics
- ME
- Other drivers

Before you begin, it is important to note that most display drivers need to have the relevant software application already installed in the system prior to installing the enhanced display drivers. In addition, many of the installation procedures assume that you are familiar with both the relevant software applications and operating system commands. Review the relevant operating system commands and the pertinent sections of your application software's user manual before performing the installation.

4.2 Introduction

The Intel® Chipset Software Installation (CSI) utility installs the Windows INF files that outline to the operating system how the chipset components will be configured. This is needed for the proper functioning of the following features:

- Core PCI PnP services
- Serial ATA interface support
- Identification of Intel chipset components in the Device Manager.

Note! The chipset driver is used for the following versions of Windows, and it has to be installed before installing all the other drivers:



- Windows 10 (64bit)

4.3 Windows Driver Setup

Enter the Advantech support website, then search product MIC-770. You can see "MIC-770" driver inside.

Appendix **A**

Programming the
Watchdog Timer

A.1 Programming the Watchdog Timer

The MIC-770's watchdog timer can be used to monitor system software operation and take corrective action if the software fails to function within the programmed period. This section describes the operation of the watchdog timer and how to program it.

A.1.1 Watchdog Timer Overview

The watchdog timer is built into the super I/O controller NCT6106D. It provides the following user-programmable functions:

- It can be enabled and disabled by user program
- Timer can be set from 1 to 255 seconds or 1 to 255 minutes
- Generates an interrupt or resets signal if the software fails to reset the timer before time-out

A.1.2 Programming the Watchdog Timer

The I/O port address of the watchdog timer is 2E (hex) and 2F (hex). 2E (hex) is the address port. 2F (hex) is the data port. You must first assign the address of register by writing an address value into address port 2E (hex), then write/read data to/from the assigned register through data port 2F (hex).

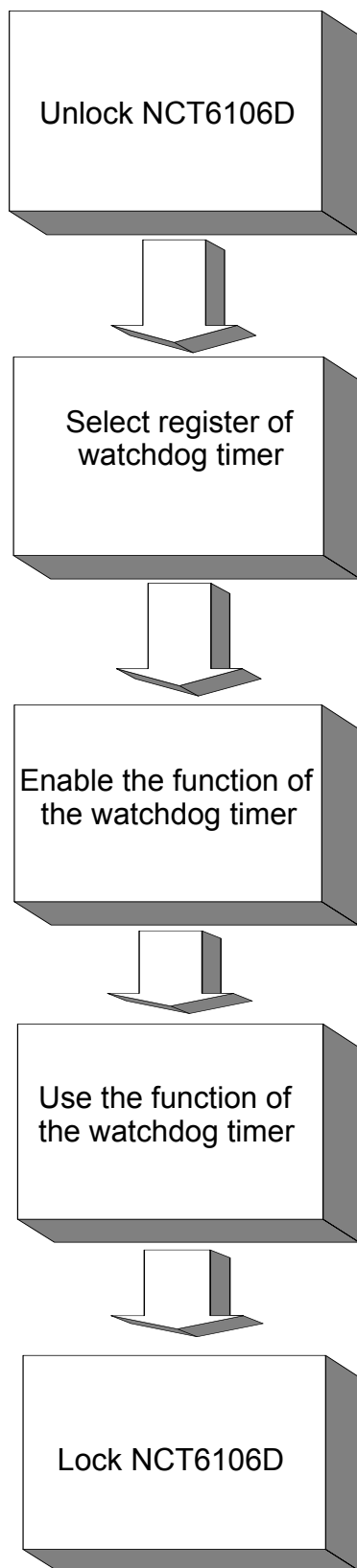

Table A.1: Watchdog Timer Registers

Address of Register (2E) Attribute		
Read/Write	Value (2F) & description	
87 (hex)	-----	Write this address to I/O address port 2E (hex) twice to unlock the NCT6106D.
07 (hex)	write	Write 08 (hex) to select register of watchdog timer.
30 (hex)	write	Write 01 (hex) to enable the function of the watchdog timer. Disabled is set as default.
F0 (hex)	write	Set seconds or minutes as units for the timer. Write 0 to bit 3: set second as counting unit. [default] Write 1 to bit 3: set minutes as counting unit.
F1 (hex)	write	0: stop timer [default] 01~FF (hex): The amount of the count, in seconds or minutes, depends on the value set in register F5 (hex). This number decides how long the watchdog timer waits for strobe before generating an interrupt or reset signal. Writing a new value to this register can reset the timer to count with the new value.
F2 (hex)	read/write	Bit 7: Write 1 to enable mouse to reset the timer, 0 to disable [default]. Bit 6: Write 1 to enable keyboard to reset the timer, 0 to disable. [default] Bit 5: Write 1 to generate a timeout signal immediately and automatically return to 0. [default=0] Bit 4: Read status of watchdog timer, 1 means timer is "timeout".
AA (hex)	-----	Write this address to I/O port 2E (hex) to lock the watchdog timer 2.

A.1.3 Example Program

1. Enable watchdog timer and set 10 sec. as timeout interval

```

;-----
Mov dx,2eh ; Unlock NCT6106D
Mov al,87h
Out dx,al
Out dx,al
;-----
Mov al,07h ; Select registers of watchdog timer
Out dx,al
Inc dx
Mov al,08h
Out dx,al
;-----
Dec dx ; Enable the function of watchdog timer
Mov al,30h
Out dx,al
Inc dx
Mov al,01h
Out dx,al
;-----
Dec dx ; Set second as counting unit
Mov al,0f0h
Out dx,al
Inc dx
In al,dx
And al,not 08h
Out dx,al
;-----
Dec dx ; Set timeout interval as 10 seconds and start counting
Mov al,0f1h
Out dx,al
Inc dx
Mov al,10
Out dx,al
;-----
Dec dx ; Lock NCT6106D
Mov al,0aah
Out dx,al

```

2. Enable watchdog timer and set 5 minutes as timeout interval

```

;-----
Mov dx,2eh ; Unlock NCT6106D
Mov al,87h
Out dx,al
Out dx,al

```

```

;-----
Mov al,07h ; Select registers of watchdog timer
Out dx,al
Inc dx
Mov al,08h
Out dx,al
;-----
Dec dx ; Enable the function of watchdog timer
Mov al,30h
Out dx,al
Inc dx
Mov al,01h
Out dx,al
;-----
Dec dx ; Set minute as counting unit
Mov al,0f0h
Out dx,al
Inc dx
In al,dx
Or al,08h
Out dx,al
;-----
Dec dx ; Set timeout interval as 5 minutes and start counting
Mov al,0f1h
Out dx,al
Inc dx
Mov al,5
Out dx,al
;-----
Dec dx ; Lock NCT6106D
Mov al,0aah
Out dx,al
3. Enable watchdog timer to be reset by mouse
;-----
Mov dx,2eh ; Unlock NCT6106D
Mov al,87h
Out dx,al
Out dx,al
;-----
Mov al,07h ; Select registers of watchdog timer
Out dx,al
Inc dx
Mov al,08h
Out dx,al
;-----

```

```

Dec dx ; Enable the function of watchdog timer
Mov al,30h
Out dx,al
Inc dx
Mov al,01h
Out dx,al
;-----
Dec dx ; Enable watchdog timer to be reset by mouse
Mov al,0f2h
Out dx,al
Inc dx
In al,dx
Or al,80h
Out dx,al
;-----
Dec dx ; Lock NCT6106D
Mov al,0aah
Out dx,al
4. Enable watchdog timer to be reset by keyboard
;-----
Mov dx,2eh ; Unlock NCT6106D
Mov al,87h
Out dx,al
Out dx,al
;-----
Mov al,07h ; Select registers of watchdog timer
Out dx,al
Inc dx
Mov al,08h
Out dx,al
;-----
Dec dx ; Enable the function of watchdog timer
Mov al,30h
Out dx,al
Inc dx
Mov al,01h
Out dx,al
;-----
Dec dx ; Enable watchdog timer to be strobed reset by keyboard
Mov al,0f2h
Out dx,al
Inc dx
In al,dx
Or al,40h
Out dx,al

```

```

;-----
Dec dx ; Lock NCT6106D
Mov al,0aah
Out dx,al
5. Generate a time-out signal without timer counting
;-----
Mov dx,2eh ; Unlock NCT6106D
Mov al,87h
Out dx,al
Out dx,al
;-----
Mov al,07h ; Select registers of watchdog timer
Out dx,al
Inc dx
Mov al,08h
Out dx,al
;-----
Dec dx ; Enable the function of watchdog timer
Mov al,30h
Out dx,al
Inc dx
Mov al,01h
Out dx,al
;-----
Dec dx ; Generate a time-out signal
Mov al,0f2h
Out dx,al ;Write 1 to bit 5 of F7 register
Inc dx
In al,dx
Or al,20h
Out dx,al
;-----
Dec dx ; Lock NCT6106D
Mov al,0aah
Out dx,al

```

Appendix **B**

Programming the
GPIO

B.1 Supported GPIO Register

Bellow are detailed description of the GPIO addresses and programming sample.

B.1.1 GPIO Registers

GPIO 1

CRF0 (GP10-GP17 I/O selection register. Default 0xFF)

When set to '1', the respective GPIO port is programmed as an input port.

When set to '0', the respective GPIO port is programmed as an output port.

CRF1 (GP10-GP17 data register. Default 0x00)

If a port is programmed to be an output port, then its respective bit can be read/written.

If a port is programmed to be an input port, then its respective bit can only be read.

CRF2 (GP10-GP17 inversion register. Default 0x00)

When set to '1', the incoming/outgoing port value is inverted.

When set to '0', the incoming/outgoing port value is the same as in data register.

GPIO 0

CREC (GP00-GP07 I/O selection register. Default 0xFF)

When set to '1', the respective GPIO port is programmed as an input port.

When set to '0', the respective GPIO port is programmed as an output port.

CREC (GP00-GP07 data register. Default 0xFF)

If a port is programmed to be an output port, then its respective bit can be read/written.

If a port is programmed to be an input port, then its respective bit can only be read.

CREE (GP00-GP07 inversion register. Default 0x00)

When set to '1', the incoming/outgoing port value is inverted.

When set to '0', the incoming/outgoing port value is the same as in data register.

Extended Function Index Registers (EFIRs)

The EFIRs are write-only registers with port address 2Eh or 4Eh on PC/AT systems.

Extended Function Data Registers (EFDRs)

The EFDRs are read/write registers with port address 2Fh or 4Fh on PC/AT systems

B.1.2 GPIO Example Program

 Enter the extended function mode, interruptible double-write

```
MOV DX, 2EH
MOV AL, 87H
OUT DX, AL
OUT DX, AL
```

 Configure logical device 7(GP10~GP17), configuration register CRE4,CRE5,CRE6

```
MOV DX, 2EH
MOV AL, 07H ; Point to Logical Device Number Reg.
OUT DX, AL
MOV DX, 2FH
MOV AL, 07H ; Select logical device 7
OUT DX, AL
```

 Configure GPIO1 I/O Register

```
MOV DX, 2EH
MOV AL, EC
OUT DX, AL
MOV DX, 2FH
MOV AL, ??H ; 0: The respective GPIO1 PIN is programmed as an output port
              ;1: The respective GPIO1 PIN is programmed as an input port.
OUT DX, AL
```

 Configure GPIO1 Inversion Register

```
MOV DX, 2EH
MOV AL, EE
OUT DX, AL
MOV DX, 2FH
MOV AL, 00H ; Set GPIO is normal not inverter
OUT DX, AL
```

 Configure GPIO1 Data Register

```
MOV DX, 2EH
MOV AL, ED
OUT DX, AL
MOV DX, 2FH
MOV AL, ??H ; Put the output value into AL
OUT DX, AL
```

Exit extended function mode

```
MOV DX, 2EH
MOV AL, AAH
OUT DX, AL
```

ADVANTECH

Enabling an Intelligent Planet

www.advantech.com

Please verify specifications before quoting. This guide is intended for reference purposes only.

All product specifications are subject to change without notice.

No part of this publication may be reproduced in any form or by any means, electronic, photocopying, recording or otherwise, without prior written permission of the publisher.

All brand and product names are trademarks or registered trademarks of their respective companies.

© Advantech Co., Ltd. 2019